

[www.rollytoys.com](http://www.rollytoys.com)



2022



 made  
in  
Germany

Franz Schneider GmbH & Co. KG



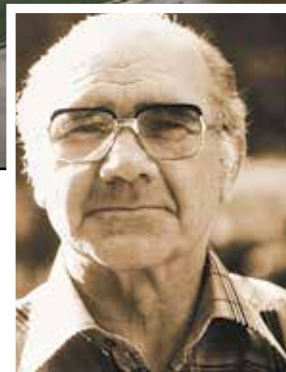

Das Spielwarenunternehmen wurde im Jahre 1938 von Franz und Rosa Schneider gegründet. Bis heute wird es in der zweiten und dritten Generation mit der Marke rolly toys als zukunftsorientiertes Familienunternehmen geführt. Seit 2020 ergänzt mit Ferbedo, eine weitere Traditionsmarke das Unternehmensportfolio der Franz Schneider GmbH & Co. KG.

The toy company was founded in 1938 by Franz and Rosa Schneider. To this day, the second and third generation company is run as a future-oriented family company with its brand rolly toys. Ferbedo, another traditional brand, has been supplementing the corporate portfolio of Franz Schneider GmbH & Co. KG since 2020.





...hat das Zeug  
zum Spielen

L'entreprise de jouets a été fondée en 1938 par Franz et Rosa Schneider. Aujourd'hui encore, les deuxième et troisième générations de la famille continuent de diriger l'entreprise familiale, avec la marque roly toys, en tant qu'entreprise familiale tournée vers l'avenir. Depuis 2020, Ferbedo, une autre marque traditionnelle, complète le portefeuille d'entreprise de Franz Schneider GmbH & Co. KG.

L'azienda di giocattoli è stata fondata nel 1938 da Franz e Rosa Schneider. Ancora oggi viene gestita dalla seconda e terza generazione con il marchio roly toys come azienda familiare orientata al futuro. Dal 2020 il portfolio aziendale della Franz Schneider GmbH & Co. KG viene arricchito da Ferbedo, un altro marchio tradizionale.



## Franz Schneider GmbH & Co. KG

Postfach 1460  
D-96459 Neustadt bei Coburg  
Germany  
Tel.: 09568 / 856-0  
Fax: 09568 / 856-190  
E-Mail: [info@rollytoys.de](mailto:info@rollytoys.de)  
[www.rollytoys.com](http://www.rollytoys.com)

**Werk I - Verwaltung**  
Siemensstraße 13-19  
D-96465 Neustadt bei Coburg  
Germany

**Werk II - Versand + Warenannahme**  
Franz-Schneider-Straße 1  
D-96465 Neustadt bei Coburg  
Germany

**Rolly Toys Italiana S.R.L.**  
Via Colonna 9  
I-31025 S.Lucia di Piave  
Tel.: 0438 / 4466  
Fax: 0438 / 27372

 **made  
in  
Germany**



**Neuheiten  
New  
Nouveauté  
Novita  
2021**



05 293 6



73 010 0

05 293 6 rollyTrac CAT S. 27

72 006 4 rollyFarmtrac Claas Arion 640 S. 41  
73 010 0 rollyFarmtrac Claas Arion 640 S. 41

72 000 2 rollyFarmtrac Steyr 6300 Terrus CVT S. 42  
73 000 1 rollyFarmtrac Steyr 6300 Terrus CVT S. 42  
73 002 5 rollyFarmtrac Steyr 6300 Terrus CVT S. 43

72 005 7 rollyFarmtrac Deutz-Fahr S. 46  
73 008 7 rollyFarmtrac Deutz-Fahr S. 46  
73 009 4 rollyFarmtrac Deutz-Fahr S. 46

73 003 2 rollyFarmtrac John Deere S. 49

71 029 4 rollyFarmtrac Fendt S. 50

72 003 3 rollyFarmtrac Valtra S. 51  
73 005 6 rollyFarmtrac Valtra S. 51

72 007 1 rollyFarmtrac Lintrac S. 52  
73 011 7 rollyFarmtrac Lintrac S. 52

64 003 4 rollyX-Trac Premium John Deere S. 56  
65 107 8 rollyX-Trac Premium John Deere S. 57

40 992 1 rollyTrac Brake (rollyX-Trac) S. 84

27 176 4 rollyMetalschubkarre S. 91



73 008 7



71 029 4

 made  
 in  
 Germany



27 176 4



73 011 7



# Inhalt Contents Sommaire Indice



73 002 5



73 003 2



73 005 6



65 107 8

Editorial	02 – 03
Neuheit, New, Nouveauté, Novita	04
Inhaltsverzeichnis	05
Erläuterungen, Explanations Explications, Informationi	06 – 09
<b>rollyMinitrac</b>	<b>10 – 15</b>
rollyKid / rolyKiddy	16 – 19
rollyKid licensed	20 – 27
rollyJunior RT	28 – 29
rollyJunior licensed	30 – 31
rollyFarmtrac	32 – 40
rollyFarmtrac Premium	41 – 52
rollyTruck	53 – 55
rollyX-Trac Premium licensed	56 – 58
rollyX-Trac Premium	59
<b>rollyTrailer</b>	<b>60 – 73</b>
rollyAccessoires	74 – 85
<b>rollyDigger</b>	<b>86 – 88</b>
<b>rollyClassic Summer</b>	<b>89 – 91</b>
<b>rollySnow Champions</b>	<b>92 – 93</b>
rollyOutdoor Games	94 – 95
rolly toys Quality	96 – 97
Index	98 – 99
Vertriebsagenturen Representatives Représentations Rappresentanti	100 – 101



**Kindergrößen in Beziehung zu Fahrzeugtyp**  
**Childsize referring to the vehicle type**  
**Le choix du tracteur se fera en fonction de la taille de l'enfant**

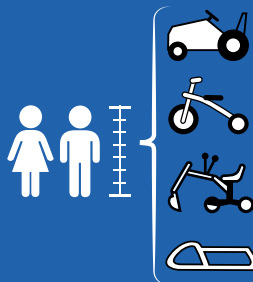

rolyMinitracs	=	68 – 104
Dreiradfahrzeuge	=	86 – 104
rolyKid	=	92 – 116
rolyJunior	=	104 – 134
rolyFarmtrac	=	104 – 134
rolyDigger	=	104 – 140
Snow Champions	=	104 – XXL
rolyX-Trac	=	110 – 140

(BG) Предупреждение!	(LT) Įspėjimas!
(CZ) Varování!	(LV) Uzmanību!
(D) Achtung!	(M) Avvis!
(DK) Advarsel!	(MK) Внимание!
(E) Aviso!	(N) OBS!
(EST) Hoiatus!	(NL) Waarschuwing!
(F) Attention!	(P) Aviso!
(FIN) Varoitus!	(PL) Ostrożnie!
(GB) Warning!	(RO) Avertisment!
(GR) Προσοχή!	(RUS) Внимание!
(H) Figyelmeztetés!	(S) Varning!
(HR) Pažnja!	(SK) Varovanie!
(I) Avviso!	(SLO) Opozorilo!
(IRL) Rabhchán!	(TR) Dikkat!

**A1**

(BG) Предупреждение!	(LT) Įspėjimas!
(CZ) Varování!	(LV) Uzmanību!
(D) Achtung!	(M) Avvis!
(DK) Advarsel!	(MK) Внимание!
(E) Aviso!	(N) OBS!
(EST) Hoiatus!	(NL) Waarschuwing!
(F) Attention!	(P) Aviso!
(FIN) Varoitus!	(PL) Ostrożnie!
(GB) Warning!	(RO) Avertisment!
(GR) Προσοχή!	(RUS) Внимание!
(H) Figyelmeztetés!	(S) Varning!
(HR) Pažnja!	(SK) Varovanie!
(I) Avviso!	(SLO) Opozorilo!
(IRL) Rabhchán!	(TR) Dikkat!

**A2**

- (BG) Внимание! Дребни части, които могат да бъдат погълнати. Опасност от задушаване!
- (CZ) Pozor! Spoklnutelné drobné součásti. Nebezpečí udušení!
- (D) Achtung! Verschluckbare Kleinteile. Erstickungsgefahr!
- (DK) Forsigtig! Smådele kan sluges. Kvælningsrisiko!
- (E) Atención! Piezas pequeñas que pueden ser tragadas. Peligro de asfixia!
- (EST) Tähelepanu! Allaneelatavad pisidetailid. Lämbumisoht!
- (F) Attention! Petites pièces détachées. Danger d'étouffement à l'ingestion!
- (FIN) Huomio! Sisältää pieniä osia. Tukehdusvaara!
- (GB) Caution! Swallowable small parts. Danger of suffocation!
- (GR) Προσοχή! Πολύ μικρά κομμάτια (κατάποση). Κίνδυνος ασφυξίας!
- (H) Vigyázat! Lenyelhető kis darabok. Fulladásveszély!
- (HR) Pažnja! Sitni dijelovi koji se mogu progutati. Opasnost od gušenja!
- (I) Attenzione! Contiene piccole parti. Rischio di soffocamento!
- (IRL) Caution! Swallowable small parts. Danger of suffocation!
- (LT) Dėmesio! Sudėtyje yra smulkių detalių. Pavojus uždusti!
- (LV) Uzmanību! Norījamas sīkas detaļas. Nosmakšanas briesmas!
- (M) Attenzjoni! Partijiet żgħar li jistghu jinbelghu! Periklu ta' soffokazzjoni!
- (MK) Внимание! Мали делчиња кои што можат да се голтнат. Постои опасност од задушвање!
- (N) OBS! Svelgbare små deler. Kvælningsfare!
- (NL) Opgelet! Insliekbare kleine onderdelen. Verstikkingsgevaar!
- (P) Atenção! Peças pequenas possíveis de ser engolidas. Perigo de asfixia!
- (PL) Uwaga! Możliwość połknięcia drobnych elementów. Niebezpieczeństwo zadławienia!
- (RO) Atenție! Piese mici ce se pot înghiți. Pericol de asfixiere!
- (RUS) Внимание! Мелкие детали, которые случайно можно проглотить. Опасность задохнуться в результате попадания в дыхательные пути!
- (S) Se upp! Sväljbara smådelar. Risk för kvävning!
- (SK) Pozor! Prehltuteľné malé časti. Nebezpečenstvo udusenja!
- (SLO) Pozor! Vsebuje majhne dele. Nevarnost zadušitve!
- (TR) Dikkat! Yutabilir küçük parçalar. Boğulma tehlikesi!

- (BG) Внимание! Дълги връзки. Опасност от удушаване!
- (CZ) Pozor! Dlouhé šňůrky. Nebezpečí uškrcení!
- (D) Achtung! Lange Schnur. Strangulationsgefahr!
- (DK) Forsigtig! Lang snøre. Risiko for strangulering!
- (E) Atención! Cuerdas largas. Peligro de estrangulamiento!
- (EST) Tähelepanu! Pikad nõõrid. Poomisoht!
- (F) Attention! Longs cordons. Danger d'étranglement!
- (FIN) Huomio! Pitkät nauhat. Kuristumisen vaara!
- (GB) Caution! Long cord. Danger of strangulation!
- (GR) Προσοχή! Μακρά κορδόνια. Κίνδυνος πνιγμού!
- (H) Vigyázat! Hosszú zsinórok. Fojtásveszély!
- (HR) Pažnja! Dugi konopi. Opasnost od strangulacija!
- (I) Attenzione! Corde lunghe. Rischio di strangolamento!
- (IRL) Caution! Long cord. Danger of strangulation!
- (LT) Dėmesio! Ilgos virvės. Pavojus pasismaugti!
- (LV) Uzmanību! Garas auklas! Pakārsšanās briesmas!
- (M) Attenzjoni! Habel twil. Periklu ta' tghalliq!
- (MK) Внимание! Долги врвци. Постои опасност од давење!
- (N) OBS! Lange snorer. Strangulasjonsfare!
- (NL) Opgelet! Lange snoeren. Wurggevaar!
- (P) Atenção! Fios compridos. Perigo de estrangulamento!
- (PL) Uwaga! Długie sznury. Niebezpieczeństwo uduszenia!
- (RO) Atenție! Sfoară lungă. Pericol de strangulare!
- (RUS) Внимание! Длинные шнуры (веревки). Опасность удушения!
- (S) Se upp! Långa snören. Risk för strypning!
- (SK) Pozor! Dlhé šnúrky. Nebezpečenstvo uškrcenia!
- (SLO) Pozor! Dolge vrvice. Nevarnost zadušitve!
- (TR) Dikkat! Uzun ipler. Boğazın sıkılma tehlikesi!

**Es gelten unsere allgemeinen Lieferbedingungen auf der Preisliste.**  
**Technische Änderungen und Farbänderungen bleiben vorbehalten.**

**Our general delivery conditions written on the price list are valid.**  
**All rights are reserved to make any technical modifications and colour changes.**

**Nous appliquons les conditions de livraison indiquées sur nos tarifs.**  
**Sous réserve de modifications techniques et de changements de teintes.**

**Sono valide tutte le condizioni scritte riportate a listino.**  
**Ci riserviamo tutti i diritti di apportare modifiche tecniche e cambiamenti di colore.**

## ERLÄUTERUNGEN

Die Bildunterschriften zu den Artikeln enthalten Angaben zur Artikelgröße (LxBxH), Artikelgewicht, Verpackungsgröße (LxWxH), Verpackungsgewicht, Verpackungsvolumen und Verpackungseinheit. Die von roly toys produzierten Artikel entsprechen der EU Norm EN 71. Alle Funktionsspielzeuge sind TÜV/GS geprüft und CE gekennzeichnet. Technische Änderungen, Farbänderungen und Änderungen im Design bleiben vorbehalten. Die roly toys Artikel werden teilmontiert ausgeliefert, die Endmontage darf nur von Erwachsenen durchgeführt werden.

## EXPLANATIONS

The legend for each item includes details about the article size (LxWxH), article weight, packing size (LxWxH), packing weight, packing volume and packing unit. All items produced by roly toys are in accordance with the EU Norm EN 71. All function toys are examined by the German Technical inspection Authority (TÜV) and are safety tested (GS). Technical changes, colour changes and changes in design are subjects to modification. The roly toys items will be delivered partly assembled; the final assembly must only be carried out by an adult.

## EXPLICATIONS

Chaque modèle est accompagné d' une légende qui indique: les dimensions du modèle (LxlxH), le poids du modèle, les dimensions du carton, les poids et le volume du carton, le colisage standard. Tous les modèles de la gamme roly toys répondent aux normes de sécurité EN 71 en vigueur dans la C.E.E. Tous les jouets de fonction sont contrôlés par le service des Mines allemand. Le fabricant se réserve le droit d' apporter sur ses modèles, si nécessaire, des modifications techniques, ainsi que des changements de couleur ou de dessin. Les articles roly toys sont livrés partiellement montés, le montage final doit impérativement être effectué par des adultes.

## INFORMAZIONI

Descrizione dei simboli presenti sotto ogni articolo: misura dell' articolo, peso netto, misura dell' imballo, peso lordo, volume dell' imballo, pezzi per confezione. Tutti i nostri giocattoli vengono prodotti e collaudati in conformità degli standard di qualità internazionali EN 71 / ASTM. Tutti i giocattoli funzionali sono testate TÜV/GS. Ci riserviamo il diritto di apportare modifiche tecniche e cambiamenti nel design e nei colori. I prodotti Rolly toys vengono forniti parzialmente assemblati, il montaggio finale può essere eseguito solo da adulti.





# rollyKonfigurator

## rollyTrailer & Accessoires



Serienausstattung



Serienausstattung – Modell abhängig



Zusatzausstattung



Nur in Kombination mit rollyTrac Lader

## rollyTracs

rollyTrac Accessoire	rollyKid 01... + 02...	rollyDumperKid 01...	rollyUnimog 03...	rollyMinitrac 13...	rollyFarmtrac 60...	rollyFarmtrac 61...	rollyKiddy 62... + 63...	rollyX- Trac Premium 64... + 65...	rollyFarmtrac Premium 70...	rollyFarmtrac Premium 71...	rollyFarmtrac Premium II 72...	rollyFarmtrac Premium II 73...	rollyJunior 80...	rollyJunior 81...
rollyTrac Brake Farmtracs 40 944 0					○	○			○	○	○	○	○	○
rollyTrac Brake X-Trac Premium 40 992 1								◐						
rollyFlashlights 40 955 6 + 40 976 1	○	○	◐		○	○		○	○	○	○	○	○	○
rollyLight & Sound 40 959 4			○		○	○		○	○	○	○	○	○	○
rollySoundwheel 40 923 5	○	○	○	○	○	○	○	○	○	○	○	○	○	○
rollySnowgrip 40 969 3					○	○			○	○	○	○	○	○
rollySnowgrip 40 966 2								○						
rollySnowgrip 40 965 5			○											
rollyTrac Air Tyres 40 984 6					○	◐							○	○
rollyTrac Air Tyres 40 924 2									○	◐	○	◐		
rollyTrac Air Tyres 40 918 1			○											
rollyTrac Sweeper 40... ..			◐		○	○		○	○	○	○	○	○	○
rollyBackhoe 40... ..	○	○	○		○	○		○	○	○	○	○	○	◐
Ladermontage + Adapter 2								○		○			○	*
rollySnow Master 40 961 7			○		○	○		○	○	○	○	○	○	○
Frontkupplung + Adapter 1								○		○			○	*
rollyTimber Loader 40 967 9								○		○			○	*
rollyTrac Lader Premium 40 896 2								◐						
Abnehmbar! rollyTrac Lader 40 934 1					○	●			○	●	○	●	○	
Fixiert! rollyJunior Lader 40 933 4													○	●
rollyKid Lader 40 931 0	◐						○							
rollyPowerwinch 40... ..			◐		○	○		○	○	○	○	○	○	○
rollyTrailer large 12... ..	○	○	○		○	○		○	○	○	○	○	○	○
rollyTrailer small 12... ..	○	○	○		○	○		○	○	○	○	○	○	○
rollyMinitrac Trailer 12... ..			○											

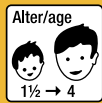

Altersangabe als Empfehlung  
Recommended age  
Indication d'âge purement indicative  
Indicazione età consigliata



Maximale Belastbarkeit  
Maximum loading capacity  
Capacité maximale  
Portata massima



Das Tragen von Schutzausrüstung wird dringend empfohlen  
It is strongly recommended to wear protective gear  
Il est fortement recommandé d'utiliser des équipements de protection  
Si consiglia di indossare un equipaggiamento protettivo



Neueit  
New item  
Nouveauté  
Novità



Garantie  
Guarantee  
Garantie  
Garanzia



Batteriebetrieb  
Battery-operated  
Modèle avec batterie et chargeur fournis  
Funziona a batteria



Sitzverstellung  
Seat shift  
Déplacement du siège  
Sella regolabile



Lenkstange höhenverstellbar  
Handlebar height-adjustable  
Colonne de direction réglable en hauteur  
Manubrio regolabile



Handbremse  
Hand-brake  
Frein à main  
Freno a mano



Zweigangschaltung  
Two gears  
Deux vitesses  
Cambio a doppia marcia



Lader  
Loader  
Pelleuse  
Caricatore



Lader abnehmbar  
Loader to dismantle  
Pelleuse à démonter  
Carrello di carico smontabile



Automatikverriegelung  
Automatically bolted  
Verrouillée automatiquement  
Blocca automaticamente



Motorhaube zu öffnen  
Bonnet opens  
Capot ouvrant  
Cofano apribile



Hupe  
Horn  
Klaxon  
Clacson



Flüsterreifen  
Noiseless tyres  
Pneus silencieux  
Ruote silenziose



Kettenschutz  
Protected Chain  
Chaîne protégée  
Cingolo protetto



Luftbereifung  
Pneumatic wheel  
Pneu souples  
Ruote gonfiabili



Die Spielwaren sind nur unter Aufsicht von Erwachsenen zu verwenden. Allgemeine Gefahren- und Gebrauchshinweise sind unbedingt zu beachten.

The toys are only to be used under adult supervision. General danger and usage notices must be unconditionally observed.

Les jouets doivent être utilisés sous la surveillance d'adultes. Les prescriptions de danger et les prescriptions d'utilisation doivent être impérativement respectées.

I giocattoli possono essere utilizzati solo sotto la supervisione di un adulto. Le istruzioni generali per l'uso e le avvertenze di pericolo devono essere rispettate rigorosamente.





1

**STEYR**  
TRAKTOREN

**CNI** LICENSED PRODUCT  
INDUSTRIAL



**1 13 201 0 rollyMinitrac Steyr 4115 Multi**

61x30x41 4,2 kg 1x

59x29,5x39 4,9 kg 0,068 m<sup>3</sup>



4 006485 132010

**2 13 233 1 rollyMinitrac MF 5470**

61x30x41 4,2 kg 1x

59x29,5x39 4,9 kg 0,068 m<sup>3</sup>



4 006485 132331

**3 13 226 3 rollyMinitrac Case 165 CVX**

61x30x41 4,2 kg 1x

59x29,5x39 4,9 kg 0,068 m<sup>3</sup>



4 006485 132263

**4 13 208 9 rollyMinitrac NH T6010**

61x30x41 4,2 kg 1x

59x29,5x39 4,9 kg 0,068 m<sup>3</sup>



4 006485 132089

**5 13 265 2 rollyMinitrac Claas Xerion**

61x30x41 4,2 kg 1x

59x29,5x39 4,9 kg 0,068 m<sup>3</sup>



4 006485 132652

**6 13 207 2 rollyMinitrac John Deere 6150 R**

61x30x41 4,2 kg 1x

59x29,5x39 4,9 kg 0,068 m<sup>3</sup>



4 006485 132072

**7 12 202 8 rollyMinitrac Trailer John Deere**

34x30x25 1,8 kg 1x

32x32x25 2,2 kg 0,026 m<sup>3</sup>



4 006485 122028

2



MASSEY FERGUSON



3



**CASE IH**  
AGRICULTURE

**CNI** LICENSED PRODUCT  
INDUSTRIAL



4



**NEW HOLLAND**  
AGRICULTURE

**CNI** LICENSED PRODUCT  
INDUSTRIAL



**CLAAS**

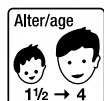

**minitrac**<sup>®</sup>

5



6

**JOHN DEERE**  
LICENSED PRODUCT

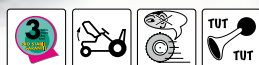
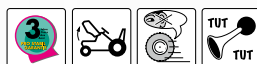

7



**Ablage unter der Motorhaube**  
Storage space under the opening bonnet  
Petit vide-poche sous le capot moteur  
Cofano apribile con vano porta oggetti







1



www.cat.com / www.caterpillar.com  
© 2022 Caterpillar. All Rights Reserved.  
CAT, CATERPILLAR, their respective logos,  
„Caterpillar Yellow,“ the „Power Edge“  
trade dress as well as corporate and product  
identity used herein, are trademarks of Caterpillar  
and may not be used without permission.  
rolly toys - Franz Schneider GmbH & Co. KG,  
a licensee of Caterpillar Inc.



**1 13 224 9 rollyMinitrac Dumper CAT**

	63x30x41		4,6 kg		1x
	59x29,5x39		5,3 kg		0,068 m <sup>3</sup>



4 006485 132249

**2 13 564 6 rollyMinitrac Dumper JCB**

	63x30x41		4,6 kg		1x
	59x29,5x39		5,3 kg		0,068 m <sup>3</sup>



4 006485 135646

**3 13 214 0 rollyMinitrac Dumper**

	63x30x41		4,6 kg		1x
	59x29,5x39		5,3 kg		0,068 m <sup>3</sup>



4 006485 132140

**4 13 210 2 rollyMinitrac Deutz-Fahr Agrokid**

	61x30x41		4,2 kg		1x
	59x29,5x39		4,9 kg		0,068 m <sup>3</sup>



4 006485 132102

**5 13 239 3 rollyMinitrac Valtra**

	61x30x41		4,2 kg		1x
	59x29,5x39		4,9 kg		0,068 m <sup>3</sup>



4 006485 132393

**6 13 277 5 rollyMinitrac Lindner**

	61x30x41		4,2 kg		1x
	59x29,5x39		4,9 kg		0,068 m <sup>3</sup>



4 006485 132775

**7 12 208 0 rollyMinitrac Trailer**

	34x30x25		1,8 kg		1x
	32x32x25		2,2 kg		0,026 m <sup>3</sup>



4 006485 122080



under permission of JCB



2

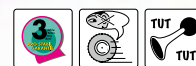

3



Alter/age  
1 1/2 → 4

minitrac<sup>®</sup>



4

DEUTZ FAHR



VALTRA

5

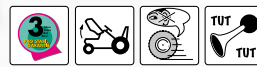

Lindner

6



7





# rolly® carabella



1

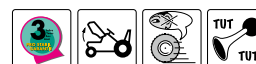

**1 13 242 3 rollyMinitrac Carabella**

61x30x41 4,2 kg 1x

59x29,5x39 4,9 kg 0,068 m<sup>3</sup>



4 006485 132423

**2 13 256 0 rollyMinitrac Volvo**

97x30x41 6,0 kg 1x

64x29x45 6,6 kg 0,083 m<sup>3</sup>



4 006485 132560



**3 16 101 0 rollyMinitruck Mack**

61x30x41 4,2 kg 1x

59x29,5x39 4,9 kg 0,068 m<sup>3</sup>



4 006485 161010

2



**4 16 100 3 rollyMinitruck Mack**

61x30x41 4,2 kg 1x

59x29,5x39 4,9 kg 0,068 m<sup>3</sup>



4 006485 161003



3

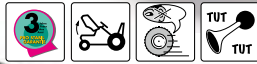

4





1



2



**1 01 212 1 rollyKid-X**

134x47x52 7,8 kg 1x  
 81,5x40x45 9,2 kg 0,147 m<sup>3</sup>



4 006485 012121

**2 02 312 7 rollyKid-X**

161x47x55 9,2 kg 1x  
 81,5x40x45 10,6 kg 0,147 m<sup>3</sup>



4 006485 023127

**3 01 216 9 rollyKid-X**

134x47x52 7,8 kg 1x  
 81,5x40x45 9,2 kg 0,147 m<sup>3</sup>



4 006485 012169

**4 02 313 4 rollyKid-X**

161x47x55 9,2 kg 1x  
 81,5x40x45 10,6 kg 0,147 m<sup>3</sup>



4 006485 023134

Alter/age  
2½ → 5

# KiX rolly<sup>®</sup>

3



4







1



2



**1 62 000 5 rollyKiddy Futura**

134x47x49 7,0 kg 1x  
 81,5x40x45 8,4 kg 0,147 m<sup>3</sup>



4 006485 620005

**2 63 003 5 rollyKiddy Futura**

162x47x53,5 8,6 kg 1x  
 81,5x40x45 10,0 kg 0,147 m<sup>3</sup>



4 006485 630035

**3 63 004 2 rollyKiddy Classic**

162x47x53,5 8,6 kg 1x  
 81,5x40x45 10,0 kg 0,147 m<sup>3</sup>



4 006485 630042

**4 02 319 6 rollyKid Deutz-Fahr**

161x47x55 9,4 kg 1x  
 81,5x42,5x45 10,8 kg 0,156 m<sup>3</sup>



4 006485 023196

**5 01 494 1 rollyKid Little Grey Fergie**

133x46x50 7,6 kg 1x  
 81,5x40x45 9,0 kg 0,147 m<sup>3</sup>



4 006485 014941

Alter/age  
2½ → 5

# rollyKis®

3



**DEUTZ**  **FAHR**

4



**LITTLE GREY**  
**FERGIE**

5





1



**CASE IH**  
AGRICULTURE

**CNI** LICENSED  
INDUSTRIAL PRODUCT



2



MASSEY FERGUSON



1 01 241 1 rolyKid Case 1170 CVX

134x47x52 8,0 kg 1x

81,5x40x45 9,4 kg 0,147 m<sup>3</sup>



4 006485 012411

2 01 230 5 rolyKid MF

134x47x52 7,8 kg 1x

81,5x40x45 9,2 kg 0,147 m<sup>3</sup>



4 006485 012305

3 01 215 2 rolyKid Zetor

82x44x52 6,1 kg 1x

81,5x40x45 7,5 kg 0,147 m<sup>3</sup>



4 006485 012152

**Zetor**

3



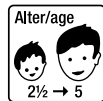

# rollyKid<sup>®</sup>

4



## FENDT



## CLAAS

5



4 01 316 6 rollyKid Fendt

134x47x52 8,0 kg 1x

81,5x42,5x45 9,4 kg 0,156 m<sup>3</sup>



4 006485 013166

5 02 507 7 rollyKid Claas Elios

110x47x55 8,2 kg 1x

81,5x40x45 9,6 kg 0,147 m<sup>3</sup>



4 006485 025077



# STEYR

TRAKTOREN



1



2

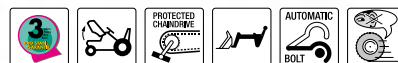

**1 01 251 0 rollyKid Steyr 6165 CVT**

134x47x52 8,2 kg 1x  
 81,5x42,5x45 9,6 kg 0,156 m<sup>3</sup>



4 006485 012510

**2 02 393 6 rollyKid Steyr 6165 CVT**

161x47x55 9,6 kg 1x  
 81,5x42,5x45 11,0 kg 0,156 m<sup>3</sup>



4 006485 023936

**3 01 307 4 rollyKid NH T 7040**

134x47x52 7,8 kg 1x  
 81,5x40x45 9,2 kg 0,147 m<sup>3</sup>



4 006485 013074

**4 02 392 9 rollyKid NH T 7040**

161x47x55 9,2 kg 1x  
 81,5x40x45 10,6 kg 0,147 m<sup>3</sup>



4 006485 023929

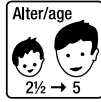

3



4





1



**VALTRA**



2



**Landini**



**3 01 219 0 rollyKid John Deere**

134x47x52 7,8 kg 1x  
 81,5x40x45 9,2 kg 0,147 m<sup>3</sup>



**1 01 252 7 rollyKid Valtra**

134x47x52 8,0 kg 1x  
 81,5x40x45 9,4 kg 0,147 m<sup>3</sup>



**4 02 311 0 rollyKid John Deere**

161x47x55 9,2 kg 1x  
 81,5x40x45 10,6 kg 0,147 m<sup>3</sup>



**2 01 184 1 rollyKid Landini**

134x47x52 8,0 kg 1x  
 81,5x40x45 9,4 kg 0,147 m<sup>3</sup>



**5 05 276 9 rollyTrac John Deere**

109x47x56 4,9 kg 1x  
 64,5x39x37,5 6,0 kg 0,094 m<sup>3</sup>



Alter/age  
2½ → 5

# rollyKis®

3

## JOHN DEERE

LICENSED PRODUCT



4



tüüüt tüüüt  
brm brm brm



5







**JCB**

under permission of JCB



1



2

**1 01 261 9 rollyKid JCB**

134x47x52 8,0 kg 1x

81,5x40x45 9,4 kg 0,147 m<sup>3</sup>



4 006485 012619



**2 02 383 7 rollyKid JCB**

161x47x55 9,4 kg 1x

81,5x42,5x45 10,8 kg 0,156 m<sup>3</sup>



4 006485 023837



**3 02 424 7 rollyKid Dumper JCB**

93x44x52 6,6 kg 1x

81,5x40x45 8,0 kg 0,147 m<sup>3</sup>



4 006485 024247

3

**4 02 328 8 rollyKid CAT**

161x47x55 9,2 kg 1x

81,5x40x45 10,6 kg 0,147 m<sup>3</sup>



4 006485 023288



**5 02 417 9 rollyKid Dumper CAT**

93x44x52 6,6 kg 1x

81,5x40x45 8,0 kg 0,147 m<sup>3</sup>



4 006485 024179



Alter/age  
2 1/2 → 5

**rollyKis**



4



www.cat.com / www.caterpillar.com  
© 2022 Caterpillar. All Rights Reserved.  
CAT, CATERPILLAR, their respective logos,  
„Caterpillar Yellow,“ the „Power Edge“  
trade dress as well as corporate and product  
identity used herein, are trademarks of Caterpillar  
and may not be used without permission.  
rolly toys - Franz Schneider GmbH & Co. KG,  
a licensee of Caterpillar Inc.



5



6

tüüüt tüüüt  
brm brm brm



**new**



6	05 293 6	rollyTrac CAT
	109x47x56	4,9 kg
	64,5x39x37,5	1x
		6,0 kg
		0,094 m³





1



2



**1 80 026 1 rollyJunior RT**

162x53x62 12,0 kg 1x

117,8x40,4x56,4 14,0 kg 0,268 m<sup>3</sup>



4 006485 800261

**2 81 146 5 rollyJunior RT**

142x53x62 11,2 kg 1x

102,8x40,4x56,4 13,0 kg 0,234 m<sup>3</sup>



4 006485 811465

**3 81 139 7 rollyJunior RT**

210x53x62 13,6 kg 1x

117,8x40,4x56,4 15,6 kg 0,268 m<sup>3</sup>



4 006485 811397

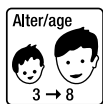

**rolly®  
junior**

3



rollyPowerwinch s. 78







1



www.cat.com / www.caterpillar.com  
 © 2022 Caterpillar. All Rights Reserved.  
 CAT, CATERPILLAR, their respective logos,  
 „Caterpillar Yellow,“ the „Power Edge“  
 trade dress as well as corporate and product  
 identity used herein, are trademarks of Caterpillar  
 and may not be used without permission.  
 rolly toys - Franz Schneider GmbH & Co. KG,  
 a licensee of Caterpillar Inc.



## JOHN DEERE

LICENSED PRODUCT

2



### 1 81 300 1 rollyJunior CAT

164,5x53x76 13,0 kg 1x  
 117,8x40,4x56,4 15,0 kg 0,268 m<sup>3</sup>



4 006485 813001

### 2 81 107 6 rollyJunior John Deere

164,5x53x76 13,0 kg 1x  
 117,8x40,4x56,4 15,0 kg 0,268 m<sup>3</sup>



4 006485 811076

### 3 81 200 4 rollyJunior JCB

164,5x53x76 13,0 kg 1x  
 117,8x40,4x56,4 15,0 kg 0,268 m<sup>3</sup>



4 006485 812004







**rolly®  
junior**

3



**JCB**

under permission of JCB



Heckbagger mit Verriegelung  
Excavator with locking mechanism  
Pelle avec verrouillage  
Escavatore posteriore con fermo

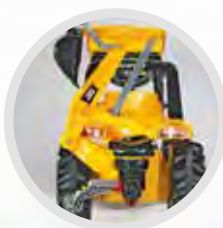





MASSEY FERGUSON



1



2



3



1 60 115 8 rollyFarmtrac MF

106x53x60 9,3 kg 1x  
 102,8x40,4x56,4 11,1 kg 0,234 m<sup>3</sup>



4 006485\*601158

2 61 113 3 rollyFarmtrac MF

142x53x81 12,6 kg 1x  
 110x52x54 15,0 kg 0,309 m<sup>3</sup>



4 006485\*611133

3 61 114 0 rollyFarmtrac MF

142x53x81 16,4 kg 1x  
 110x52x54 18,8 kg 0,309 m<sup>3</sup>



4 006485\*611140



# rolly FARMTRAC

4

# FENDT



5



6



**4 60 102 8 rollyFarmtrac Fendt 211 Vario**

106x53x60 9,3 kg 1x

117,8x40,4x56,4 11,3 kg 0,268 m<sup>3</sup>



4 006485 601028

**5 61 105 8 rollyFarmtrac Fendt 211 Vario**

142x53x81 12,6 kg 1x

110x52x54 15,0 kg 0,309 m<sup>3</sup>



4 006485 611058

**6 61 108 9 rollyFarmtrac Fendt 211 Vario**

142x53x81 16,4 kg 1x

110x52x54 18,8 kg 0,309 m<sup>3</sup>



4 006485 611089





1



2

**1 60 124 0 rollyFarmtrac Deutz-Fahr**

	106x53x60		9,3 kg		1x
	102,8x40,4x56,4		11,1 kg		0,234 m <sup>3</sup>



4 006485 601240

**2 61 120 1 rollyFarmtrac Deutz-Fahr**

	142x53x81		12,6 kg		1x
	110x52x54		15,0 kg		0,309 m <sup>3</sup>



4 006485 611201

**3 61 121 8 rollyFarmtrac Deutz-Fahr**

	142x53x81		16,4 kg		1x
	110x52x54		18,8 kg		0,309 m <sup>3</sup>



4 006485 611218

**4 60 131 8 rollyFarmtrac Fiat Centenario**

	150x53x62		9,2 kg		1x
	102,8x40,4x56,4		11,0 kg		0,234 m <sup>3</sup>



4 006485 601318

**5 61 100 3 rollyFarmtrac JCB 8250**

	142x53x81		12,6 kg		1x
	110x52x54		15,0 kg		0,309 m <sup>3</sup>



4 006485 611003



3



Alter/age  
3 → 8

**Frolly®**  
**FARMTRAC**

**CNI** LICENSED  
INDUSTRIAL PRODUCT

4



**100**  
FIAT CENTENARIO  
TRATTORI

5

**JCB**

under permission of JCB





# CASE II

AGRICULTURE



1



2



3



**1 60 105 9 rollyFarmtrac Case Puma**

	106x53x60		9,3 kg		1x
	102,8x40,4x56,4		11,1 kg		0,234 m <sup>3</sup>

4 006485 601059

**2 61 106 5 rollyFarmtrac Case Puma**

	142x53x81		12,6 kg		1x
	110x52x54		15,0 kg		0,309 m <sup>3</sup>

4 006485 611065

**3 61 112 6 rollyFarmtrac Case Puma**

	142x53x81		16,4 kg		1x
	110x52x54		18,8 kg		0,309 m <sup>3</sup>

4 006485 611126

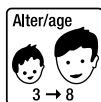

**rolly**  
**FARMTRAC**

**NEW HOLLAND**  
AGRICULTURE

**CNH** LICENSED  
INDUSTRIAL PRODUCT

4



5



6



4 60 129 5 rollyFarmtrac NH

106x53x60 9,3 kg 1x

102,8x40,4x56,4 11,1 kg 0,234 m<sup>3</sup>



4 006485 601295

5 61 125 6 rollyFarmtrac NH

142x53x81 12,6 kg 1x

110x52x54 15,0 kg 0,309 m<sup>3</sup>



4 006485 611256

6 61 127 0 rollyFarmtrac NH

142x53x81 16,4 kg 1x

110x52x54 18,8 kg 0,309 m<sup>3</sup>



4 006485 611270



1



Zweigangschaltung und Bremse  
Two gears and brake  
Deux vitesses et frein  
Cambio a doppia marcia e freno

**1 04 669 0 rollyFarmtrac MB 1500**

	148x51x66		12,8 kg		1x
	113,5x52x52		15,0 kg		0,307 m <sup>3</sup>



4 006485 046690

**2 60 106 6 rollyFarmtrac JD 6210 R**

	106x53x60		9,3 kg		1x
	117,8x40,4x56,4		11,3 kg		0,268 m <sup>3</sup>



4 006485 601066

**3 61 109 6 rollyFarmtrac JD 6210 R**

	142x53x81		12,6 kg		1x
	110x52x54		15,0 kg		0,309 m <sup>3</sup>



4 006485 611096

**4 61 110 2 rollyFarmtrac JD 6210 R**

	142x53x81		16,4 kg		1x
	110x52x54		18,8 kg		0,309 m <sup>3</sup>



4 006485 611102



2



**JOHN DEERE**  
LICENSED PRODUCT

Alter/age  
3 → 8

Frolly<sup>®</sup>  
FARMTRAC

3



4







# CLAAS

1



2



1 60 104 2 rollyFarmtrac Claas Axos 340

106x53x60 9,3 kg 1x

102,8x40,4x56,4 11,1 kg 0,234 m<sup>3</sup>



4 006485 601042

2 61 104 1 rollyFarmtrac Claas Axos 340

142x53x81 12,6 kg 1x

110x52x54 15,0 kg 0,309 m<sup>3</sup>



4 006485 611041

3 72 006 4 rollyFarmtrac Claas Arion 640

114x52,5x65,5 12,2 kg 1x

119,5x55x54 14,3 kg 0,355 m<sup>3</sup>



4 006485 720064

4 73 010 0 rollyFarmtrac Claas Arion 640

150x52,5x76 14,2 kg 1x

119,5x55x54 17,1 kg 0,355 m<sup>3</sup>



4 006485 730100

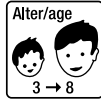

# Frolly<sup>®</sup> FARMTRAC

## Premium

# CLAAS

3



Mit beidseitiger Verriegelung  
With locking on both sides  
Avec double verrouillage  
Con doppia chiusura



4



Der Schaufellader ist komplett abnehmbar  
The shovel loader can be removed completely  
Le chargeur à pelle est entièrement démontable  
Le rollyTrac Lader può essere completamente smontata





# STEYR

TRAKTOREN

**CNI** INDUSTRIAL LICENSED PRODUCT

**new**

1



2



**new**

**1 72 000 2 rollyFarmtrac Steyr 6300 Terrus CVT**

114x52,5x65 12,2 kg 1x

119,5x55x54 14,1 kg 0,355 m<sup>3</sup>



4 006485 720002



**2 73 000 1 rollyFarmtrac Steyr 6300 Terrus CVT**

150x52,5x76 14,2 kg 1x

119,5x55x54 17,1 kg 0,355 m<sup>3</sup>



4 006485 730001

**3 73 002 5 rollyFarmtrac Steyr 6300 Terrus CVT**

150x52,5x76 17,6 kg 1x

119,5x55x54 21,8 kg 0,355 m<sup>3</sup>



4 006485 730025

Alter/age  
3 → 8

Frolly®  
FARMTRAC

Premium

new

3







1



erhältlich bis 08/2022  
available till 08/2022



2



erhältlich bis 08/2022  
available till 08/2022

**1 70 003 5 rollyFarmtrac Deutz-Fahr**

108,5x52,5x65,5 11,7 kg 1x  
 110x52x54 14,1 kg 0,309 m<sup>3</sup>



**2 71 003 4 rollyFarmtrac Deutz-Fahr**

146x52,5x77 14,7 kg 1x  
 110x52x54 17,1 kg 0,309 m<sup>3</sup>



**3 71 013 3 rollyFarmtrac Deutz-Fahr**

146x52,5x77 19,4 kg 1x  
 110x52x54 21,8 kg 0,309 m<sup>3</sup>



**4 71 034 8 rollyFarmtrac Deutz-Fahr Warrior**

146x52,5x77 14,7 kg 1x  
 110x52x54 17,1 kg 0,309 m<sup>3</sup>



3



erhältlich bis 08/2022  
available till 08/2022



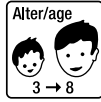

# Frolly<sup>®</sup> FARMTRAC

## Premium

Der Schaufellader ist komplett abnehmbar  
The shovel loader can be removed completely  
Le chargeur à pelle est entièrement démontable  
Le rollyTrac Lader può essere completamente smontata



4



Mit beidseitiger Verriegelung  
With locking on both sides  
Avec double verrouillage  
Con doppia chiusura





1



erhältlich ab 06/2022  
available from 06/2022

2



erhältlich ab 06/2022  
available from 06/2022

3



erhältlich ab 06/2022  
available from 06/2022

**1 72 005 7 rollyFarmtrac Deutz-Fahr**

114x52,5x65 12,2 kg 1x

119,5x55x54 14,1 kg 0,355 m<sup>3</sup>



4 006485 720057

**2 73 008 7 rollyFarmtrac Deutz-Fahr**

150x52,5x76 14,2 kg 1x

119,5x55x54 17,1 kg 0,355 m<sup>3</sup>



4 006485 730087

**3 73 009 4 rollyFarmtrac Deutz-Fahr**

150x52,5x76 17,6 kg 1x

119,5x55x54 21,8 kg 0,355 m<sup>3</sup>



4 006485 730094



**rolly<sup>®</sup>  
FARMTRAC**

**Premium**



*Die patentierte rolly toys Sitzverstellung  
jetzt auch bei der rollyFarmtrac Premium-Linie*

*The patented rolly toys seat adjustment  
now also on the rollyFarmtrac Premium line*





# JOHN DEERE

LICENSED PRODUCT

Mit beidseitiger Verriegelung  
With locking on both sides  
Avec double verrouillage  
Con doppia chiusura



1



Der Schaufellader ist komplett abnehmbar  
The shovel loader can be removed completely  
Le chargeur à pelle est entièrement démontable  
La rollyTrac Lader può essere completamente smontata

2



**1 70 002 8 rollyFarmtrac John Deere 7930**

114x52,5x65,5 12,2 kg 1x  
 110x52x54 14,6 kg 0,309 m<sup>3</sup>



**2 71 002 7 rollyFarmtrac John Deere 7930**

146x52,5x77 14,7 kg 1x  
 110x52x54 17,1 kg 0,309 m<sup>3</sup>



**3 71 012 6 rollyFarmtrac John Deere 7930**

146x52,5x77 20,4 kg 1x  
 110x52x54 22,8 kg 0,309 m<sup>3</sup>



**4 73 003 2 rollyFarmtrac John Deere 7310R**

150x52,5x76 14,2 kg 1x  
 119,5x55x54 17,1 kg 0,355 m<sup>3</sup>



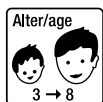

**Froly<sup>®</sup>**  
**FARMTRAC**

**Premium**

3



Zweigangschaltung und Bremse

Two gears and brake

Deux vitesses et frein

Cambio a doppia marcia e freno

4





# FENDT



1



1 71 026 3 rollyFarmtrac Fendt

146x52,5x78 14,7 kg 1x

110x52x55 17,1 kg 0,309 m<sup>3</sup>



4 006485 710263

2 71 029 4 rollyFarmtrac Fendt

146x52,5x77 20,4 kg 1x

110x52x54 22,8 kg 0,309 m<sup>3</sup>



4 006485 710294

3 70 027 1 rollyFarmtrac Valtra

114x52,5x65,5 11,9kg 1x

110x52x54 14,3 kg 0,309 m<sup>3</sup>



4 006485 700271

4 71 040 9 rollyFarmtrac Valtra

146x52,5x77 14,7 kg 1x

110x52x54 17,1 kg 0,309 m<sup>3</sup>



4 006485 710409

5 72 003 3 rollyFarmtrac Valtra

114x52,5x65 12,2 kg 1x

119,5x55x54 14,6 kg 0,355 m<sup>3</sup>



4 006485 720033

6 73 005 6 rollyFarmtrac Valtra

150x52,5x76 14,2 kg 1x

119,5x55x54 17,1 kg 0,355 m<sup>3</sup>



4 006485 730056



2



# VALTRA



3



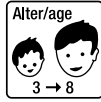

**Froly®  
FARMTRAC**

**Premium**

**VALTRA**

4



5



Artikel erhältlich ab August 2022  
Article available from August 2022

6





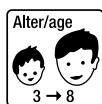

**rolly®  
FARMTRAC**

**Premium**

**Lindner**



1



2



**1 72 007 1 rollyFarmtrac Lintrac**

114x52,5x65 12,2 kg 1x

119,5x55x54 14,6 kg 0,355 m<sup>3</sup>



4 006485 720071

**2 73 011 7 rollyFarmtrac Lintrac**

150x52,5x76 14,2 kg 1x

119,5x55x54 17,1 kg 0,355 m<sup>3</sup>



4 006485 730117



rolly®  
**Truck-Line**

# VOLVO

The VOLVO trademarks (word and device), other related trademarks, if applicable, and the Volvo designs are licensed by the AB Volvo Group



3

3 88 100 0 rollyTruck Volvo

 126x51x59,5  13,2 kg  1x

 120x56x57,5  16,0 kg  0,386 m<sup>3</sup>







1



**1 03 822 0 rollyUnimog Fire**

118x54x81 17,2 kg 1x

119,5x54x55 19,8 kg 0,355 m<sup>3</sup>



2

**2 03 823 7 rollyUnimog Service**

118x54x81 17,2 kg 1x

119,5x54x55 19,8 kg 0,355 m<sup>3</sup>



**3 03 824 4 rollyUnimog Forst**

130x54x73 15,8 kg 1x

119,5x54x55 18,4 kg 0,355 m<sup>3</sup>



**4 03 825 1 rollyUnimog Polizei**

118x54x81 17,2 kg 1x

119,5x54x55 19,8 kg 0,355 m<sup>3</sup>



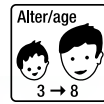

rolly®  
**Truck-Line**

3



4





# JOHN DEERE

LICENSED PRODUCT



1



2



**1 64 003 4 rollyX-Trac Premium John Deere**

119x71x56,5 15,1 kg 1x  
 120x57,5x57 18,0 kg 0,393 m<sup>3</sup>



**2 65 104 7 rollyX-Trac Premium John Deere**

154x91x56,5 17,9 kg 1x  
 120x57,5x57 20,7 kg 0,393 m<sup>3</sup>



**3 65 107 8 rollyX-Trac Premium John Deere**

154x91x56,5 19,2 kg 1x  
 120x57,5x57 22 kg 0,393 m<sup>3</sup>





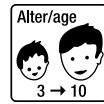

reilly®  
**X-trac**  
Premium

new

3





# CLAAS

1



2



3



**1 64 008 9 rollyX-Trac Premium Claas**

	119x71x56,5		15,1 kg		1x
	120x57,5x57		18,0 kg		0,393 m³



**2 65 109 2 rollyX-Trac Premium Claas**

	154x91x56,5		17,9 kg		1x
	120x57,5x57		20,7kg		0,393 m³



**3 65 112 2 rollyX-Trac Premium Claas**

	154x91x56,5		19,2 kg		1x
	120x57,5x57		22,0 kg		0,393 m³





**rolly**  
**X-trac**  
Premium

4

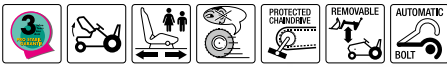

5



Zweigangschaltung und Bremse  
Two gears and brake  
Deux vitesses et frein  
Cambio a doppia marcia e freno



4 65 100 9 rollyX-Trac Premium

154x91x56,5 17,9 kg 1x  
120x57,5x57 20,7kg 0,393 m<sup>3</sup>



5 65 101 6 rollyX-Trac Premium

154x91x56,5 19,2 kg 1x  
120x57,5x57 22,0 kg 0,393 m<sup>3</sup>



140  
128  
110





1



Mit Kurbel  
With Crank  
Avec manivelle  
Con manovella



**JOHN DEERE**  
LICENSED PRODUCT

2



**1 12 501 2 rollyMulti Trailer**

113x45,5x63 14,6 kg 1x  
 94,5x42x47 16,2 kg 0,187 m<sup>3</sup>



**2 12 504 3 rollyMulti Trailer John Deere**

113x45,5x63 14,6 kg 1x  
 94,5x42x47 16,2 kg 0,187 m<sup>3</sup>



**3 12 500 5 rollyMulti Trailer**

113x45,5x48 10,0 kg 1x  
 87x40x47 11,4 kg 0,164 m<sup>3</sup>







rollyTrailer



3

Anhängerkupplung hinten  
Trailer hitch behind  
Crochet d'attelage arrière  
Rimorchio intoppo dietro





1



ausgezeichnet 1996



**1 12 110 6 rollyMega Trailer**

88x45x47 7,9 kg 1x  
 88x24,2x43,5 9,1 kg 0,093 m<sup>3</sup>



**2 12 150 2 rollyMega Trailer**

88x45x47 7,9 kg 1x  
 88x24,2x43,5 9,1 kg 0,093 m<sup>3</sup>



**3 12 220 2 rollyMega Trailer**

88x45x47 7,9 kg 1x  
 88x24,2x43,5 9,1 kg 0,093 m<sup>3</sup>



**4 12 200 4 rollyMega Trailer**

88x45x47 7,9 kg 1x  
 88x24,2x43,5 9,1 kg 0,093 m<sup>3</sup>



**5 12 301 8 rollyMega Trailer**

88x45x47 7,9 kg 1x  
 88x24,2x43,5 9,1 kg 0,093 m<sup>3</sup>



2



3





rollyTrailer

4



5



Mit Kurbel  
With crank  
Avec manivelle  
Con manovella







1

**JOHN DEERE**  
LICENSED PRODUCT



**1 12 216 5 rollyHalbpipe JD**

	89x45x43		5,8 kg		1x
	79x31x42		6,8 kg		0,103 m <sup>3</sup>



4 006485 122165



**2 12 224 0 rollyHalbpipe Deutz-Fahr**

	89x45x43		5,8 kg		1x
	79x31x42		6,8 kg		0,103 m <sup>3</sup>



4 006485 122240



2



**3 12 319 3 rollyHalbpipe Single**

	76x45x42,5		3,6 kg		1x
	79x31x42		4,6 kg		0,103 m <sup>3</sup>



4 006485 123193

**4 12 221 9 rollyHalbpipe Claas**

	89x45x43		5,8 kg		1x
	79x31x42		6,8 kg		0,103 m <sup>3</sup>



4 006485 122219

**5 12 326 1 rollyHalbpipe Krampe HP20**

	89x45x43		5,8 kg		1x
	79x31x42		6,8 kg		0,103 m <sup>3</sup>



4 006485 123261

**6 12 323 0 rollyHalbpipe Krampe**

	89x45x43		5,8 kg		1x
	79x31x42		6,8 kg		0,103 m <sup>3</sup>



4 006485 123230



3





rollyTrailer

# CLAAS



4



5

**Krampe**  
QUALITÄT AUF RÄDERN









6













**1 12 393 3 rollyContainer Set**

-  98x45x51  10,7 kg  1x
-  101x59x49  13,1 kg  0,292 m<sup>3</sup>



4 006485 123933





**2 12 509 8 rollyContainer John Deere**

-  98x45x51  8,4 kg  1x
-  94,5x42x47  10,0 kg  0,187 m<sup>3</sup>



4 006485 125098







**3 12 322 3 rollyContainer Krampe**

-  98x45x51  8,4 kg  1x
-  94,5x42x47  10,0 kg  0,187 m<sup>3</sup>



4 006485 123223







**4 12 320 9 rollyMulti Trailer Joskin**

-  113x45,5x48  11,8 kg  1x
-  94,5x42x47  13,4 kg  0,187 m<sup>3</sup>



4 006485 123209

**5 12 226 4 rollyHalfpipe Joskin**

-  89x45x43  5,8 kg  1x
-  79x31x42  6,8 kg  0,103 m<sup>3</sup>



4 006485 122264



**JOHN DEERE**  
LICENSED PRODUCT



2





rollyTrailer

3



**Krampe**

QUALITÄT AUF RÄDERN



**JOSKIN**

4



Mit Kurbel  
With Crank  
Avec manivelle  
Con manovella



5







Wasserhahn mit großer Wasserglocke  
 Tap with water spreader device  
 Robinet – grand debit  
 Rubinetto con getto a ventaglio

**1 12 212 7 rollyTanker**

	98x44x55		5,6 kg		1x
	72x47x40		7,0 kg		0,135 m³



**2 12 277 6 rollyTanker**

	98x46x62		4,7 kg		1x
	72x47x40		6,1 kg		0,135 m³



**3 12 265 3 rollyTanker**

	98x44x55		5,6 kg		1x
	72x47x40		7,0 kg		0,135 m³



**4 12 275 2 rollyTanker John Deere**

	98x44x62		6,0 kg		1x
	72x47x40		7,4 kg		0,135 m³



**5 12 296 7 rollyVacumax Fire**

	75x45x43		2,7 kg		1x
	73x31x28		3,5 kg		0,063 m³



**6 12 286 8 rollyVacumax**

	75x45x43		2,7 kg		1x
	73x31x28		3,5 kg		0,063 m³



**7 40 940 2 rollyPompa**

	30x10x10		0,3 kg		1x
	30,5x10,5x10,5		0,4 kg		0,003 m³



1



2



3





rollyTrailer

# JOHN DEERE

LICENSED PRODUCT



7  
Pumpe mit Spritze  
Pump with spray nozzle  
Pompe avec arroseur  
Pompa con spruzzatore

Passt an alle roolly toys Tankwagen  
Fits all roolly toys tankers  
Étudié pour toutes les citernes tractées  
Va bene per tutti i serbatoi





**1 12 885 3 rollyKipper II Claas**

56x46,5x34 2,4 kg 1x  
 52,5x28,5x40 3,1 kg 0,060 m<sup>3</sup>



4 006485 128853

**2 12 884 6 rollyKipper II**

56x46,5x34 2,4 kg 1x  
 52,5x28,5x40 3,1 kg 0,060 m<sup>3</sup>



4 006485 128846

**3 12 881 5 rollyKipper II**

56x46,5x34 2,4 kg 1x  
 52,5x28,5x40 3,1 kg 0,060 m<sup>3</sup>



4 006485 128815

**4 12 882 2 rollyKipper II John Deere**

56x46,5x34 2,4 kg 1x  
 52,5x28,5x40 3,1 kg 0,060 m<sup>3</sup>



4 006485 128822

**5 12 215 8 rollyTimber Trailer**

82x46x65 6,0 kg 1x  
 89x34x43 7,4 kg 0,130 m<sup>3</sup>



4 006485 122158

**6 40 963 1 rollyTimber**

58x9,5x9,5 1,3 kg 1x  
 64x32x23 1,7 kg 0,047 m<sup>3</sup>



4 006485 409631

**7 12 247 9 rollyHay Wagon Pöttinger**

83x40x67 5,6 kg 1x  
 79x43x25 6,6 kg 0,085 m<sup>3</sup>



4 006485 122479

**8 12 298 1 rollyHay Wagon**

83x40x67 5,6 kg 1x  
 79x43x25 6,6 kg 0,085 m<sup>3</sup>



4 006485 122981

## CLAAS



1



2



3



4



**JOHN DEERE**  
 LICENSED PRODUCT



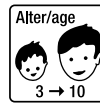

# rollyTrailer

5



Automatikverriegelung  
Automatic locking  
Verrouillage automatique  
Fermo automatico



6x Rundhölzer aus Kunststoff  
6x plastic woodround  
6x rouleau de bois en plastique  
6x tronchi in plastica

6



7



8





# JOHN DEERE

LICENSED PRODUCT



**1** 12 209 7 **rollyFarm Trailer**

62x46x37 3,1 kg 1x  
 64x23x32 3,5 kg 0,047 m<sup>3</sup>



**2** 12 210 3 **rollyFarm Trailer John Deere**

62x46x37 3,1 kg 1x  
 64x23x32 3,5 kg 0,047 m<sup>3</sup>



**3** 12 174 8 **rollyKid Trailer**

57x46,5x26,5 4x1,55 kg 4x  
 87x34,5x54 7,5 kg 0,162 m<sup>3</sup>



**4** 12 172 4 **rollyKid Trailer**

57x46,5x26,5 4x1,55 kg 4x  
 87x34,5x54 7,5 kg 0,162 m<sup>3</sup>



**5** 12 176 2 **rollyKid Trailer**

57x46,5x26,5 4x1,55 kg 4x  
 87x34,5x54 7,5 kg 0,162 m<sup>3</sup>



**6** 12 171 7 **rollyKid Trailer**

57x46,5x26,5 4x1,55 kg 4x  
 87x34,5x54 7,5 kg 0,162 m<sup>3</sup>

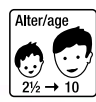

# rollyKid Trailer





rollyTrailer

# JOHN DEERE

LICENSED PRODUCT



7



**Geschützter Integralantrieb**  
Covered integral drive  
transmission protégée  
Trasmissione con protezione

# AMAZONE



8



**7 12 511 1 rollyStreumax John Deere**

	69x47,5x49		4,4 Kg		1x
	59x37,5x44		5,4 Kg		0,097 m³



4 006485 125111

**8 12 510 4 rollyStreumax Amazone**







	69x47,5x49		4,4 Kg		1x
	59x37,5x44		5,4 Kg		0,097 m³



4 006485 125104









**1 12 386 5 rollyScraper**

 69x35x35  1,8 kg  1x  
 63x23x12  2,0 kg  0,017 m<sup>3</sup>









**2 12 381 0 rollyFarm Roller**

 56x52x25  3,0 kg  1x  
 56,5x26,5x26,5  3,6 kg  0,040 m<sup>3</sup>



**3 12 384 1 rollyCambridge**

 61x90x27  5,4 kg  1x  
 52,5x35x24  6,0 kg  0,044 m<sup>3</sup>



**4 40 892 4 rollyBox Claas**

 44x31x21  1,9 kg  1x  
 45x30,5x23  2,3 kg  0,032 m<sup>3</sup>



**5 40 894 8 rollyBox**

 44x31x21  1,9 kg  1x  
 45x30,5x23  2,3 kg  0,032 m<sup>3</sup>



**6 40 893 1 rollyBox**

 44x31x21  1,9 kg  1x  
 45x30,5x23  2,3 kg  0,032 m<sup>3</sup>







**7 40 889 4 rollyBox rollyMilchkannen**

 44x31x21  2,4 kg  1x  
 45x30,5x23  3,0 kg  0,032 m<sup>3</sup>



**8 40 938 9 rollyMilk Churns (4 pcs)**

 21x10,5x10,5  4,4 kg  6x  
 73x51x28  5,0 kg  0,104 m<sup>3</sup>



1



2



3





# rolly BOX

4



5



6



7



8





- rollyKiddy
- rollyKid



**40 931 0 rollyKid Lader**

	61x37x31		1,9 kg		1x
	41x21x32		2,2 kg		0,028 m <sup>3</sup>



- rollyJunior



**40 933 4 rollyJunior Lader**

	81x37x33		2,1 kg		1x
	64x23x32		2,5 kg		0,047 m <sup>3</sup>

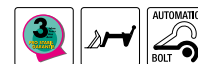

- rollyFarmtrac
- rollyFarmtrac Classic
- rollyFarmtrac Premium
- rollyX-Trac
- rollyX-Trac Premium



**40 934 1 rollyTrac Lader**

	83x35x40		2,7 kg		1x
	58,5x43,5x38,5		3,5 kg		0,098 m <sup>3</sup>

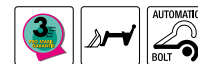

- rollyFarmtrac
- rollyFarmtrac Classic
- rollyFarmtrac Premium
- rollyX-Trac
- rollyX-Trac Premium



**40 939 6 rollyTrac Lader**

	83x35x40		2,7 kg		1x
	58,5x43,5x38,5		3,5 kg		0,098 m <sup>3</sup>

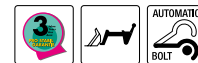



40 895 5 rollyTrac Lader Premium

85x50,5x36 2,8 kg 1x  
 59,5x43,5x38,5 3,6 kg 0,100 m<sup>3</sup>

4 006485 408955



rollyX-Trac Premium



40 896 2 rollyTrac Lader Premium

85x50,5x36 2,8 kg 1x  
 59,5x43,5x38,5 3,6 kg 0,100 m<sup>3</sup>

4 006485 408962



rollyX-Trac Premium



40 967 9 rollyTimber Loader

42x35x30 1,0 kg 1x  
 37x30x17 1,2 kg 0,019 m<sup>3</sup>

4 006485 409679



- rollyFarmtrac
- rollyFarmtrac Classic
- rollyFarmtrac Premium
- rollyX-Trac
- rollyX-Trac Premium



Für Traktoren mit rollyTrac Lader  
 For tractors with rollyTrac Lader  
 Pour tracteurs avec chargeur rollyTrac Lader  
 Adattabile a trattori con ruspa rollyTrac Lader





1



2



3



4



1 40 900 6 rollyPowerwinch

	38x8x26		0,8 kg		1x
	40x27x12		1,0 kg		0,013 m <sup>3</sup>



4 006485 409006

2 40 928 0 rollyPowerwinch

	38x8x26		0,8 kg		1x
	40x27x12		1,0 kg		0,013 m <sup>3</sup>



4 006485 409280

3 40 898 6 rollyPowerwinch

	38x8x26		0,8 kg		1x
	40x27x12		1,0 kg		0,013 m <sup>3</sup>



4 006485 408986

4 40 972 3 rollySweepy

	49x44x40		3,1 kg		1x
	52x36x26,5		3,7 kg		0,050 m <sup>3</sup>



4 006485 409723

5 40 970 9 rollyTrac Sweeper

	65x57,5x44		4,3 kg		1x
	60x58,5x23		5,2 kg		0,081 m <sup>3</sup>



4 006485 409709

6 40 961 7 rollySnow Master

	55x34,5x13,5		2,8 kg		1x
	56,5x34x19,5		3,2 kg		0,037 m <sup>3</sup>



4 006485 409617

7 40 899 3 rollySnow Master

	55x34,5x13,5		2,8 kg		1x
	56,5x34x19,5		3,2 kg		0,037 m <sup>3</sup>



4 006485 408993

Frontanbau – Heckanbau  
 Front-attachment – rear-attachment  
 Montage frontale – montage arrière  
 Montaggio frontale – montaggio posteriore

Voll funktionstüchtige Anbaukehrmaschine,  
 mit rotierender Bürstenwalze. Der Auffang-  
 behälter ist zum Entleeren abnehmbar.

Fully functional road sweeper, with rotating  
 brush roller. The collection container can be  
 removed to be emptied.

Balayeuse fonctionnelle, avec rouleau brossier  
 rotatif. Le réservoir collecteur est démontable  
 pour l'évacuation.

Spazzatrice completamente funzionale,  
 con cilindro a spazzola rotante. Il recipiente  
 di raccolta è rimuovibile per essere svuotato.

- rollyMinitrac
- rollyKiddy
- rollyKid
- rollyJunior
- rollyFarmtrac
- rollyFarmtrac Classic
- rollyFarmtrac Premium
- rollyX-Trac
- rollyX-Trac Premium
- rollyTruck (Unimog)

rolly<sup>®</sup>  
 TracSweeper

5





## Planierschild für Traktoren

Sand and snow plow for tractors

Pelle niveleuse pour tracteurs

6



7







1



- rollyMinitrac
- rollyKiddy
- rollyKid
- rollyJunior
- rollyFarmtrac
- rollyFarmtrac Classic
- rollyFarmtrac Premium
- rollyX-Trac
- rollyX-Trac Premium
- rollyTruck (Unimog)



2



**1 40 932 7 rollyBackhoe**

40x23x78 1,8 kg 1x

77x41,5x16,5 2,4 kg 0,053 m³



4 006485 409327

**2 40 988 4 rollySweepy**

49x44x40 3,1 kg 1x

52x36x26,5 3,7 kg 0,050 m³



4 006485 409884

**3 40 935 8 rollyBackhoe John Deere**

40x23x78 1,8 kg 1x

77x41,5x16,5 2,4 kg 0,053 m³



4 006485 409358

**4 40 971 6 rollyTrac Sweeper John Deere**

65x57,5x44 4,3 kg 1x

60x58,5x23 5,2 kg 0,081 m³



4 006485 409716





3



# JOHN DEERE

LICENSED PRODUCT

4



- rollyMinitrac
- rollyKiddy
- rollyKid
- rollyJunior
- rollyFarmtrac
- rollyFarmtrac Classic
- rollyFarmtrac Premium
- rollyX-Trac
- rollyX-Trac Premium
- rollyTruck (Unimog)







**40 918 1 rollyTrac Air Tyres**

31x9,5 (4x) 6,7 kg 1x  
 38,5x32x32 7,1 kg 0,039 m<sup>3</sup>

4 006485 409181



**Luftbereifung, 4 Stck.**  
 pneumatic wheels, 4 pieces  
 pneu souples, 4 pièces  
 ruote gonfiabili, 4 pezzi

- rollyFarmtrac Classic
- rollyTrac (Unimog)

**40 984 6 rollyTrac Air Tyres**

26x9,5 (2x)  
 32,5x11 (2x) 7,7 kg 1x  
 43x35,5x35,5 8,3 kg 0,054 m<sup>3</sup>

4 006485 409846



**Luftbereifung, 4 Stck.**  
 pneumatic wheels, 4 pieces  
 pneu souples, 4 pièces  
 ruote gonfiabili, 4 pezzi

- rollyMinitrac
- rollyKiddy
- rollyKid
- rollyJunior
- rollyFarmtrac
- rollyFarmtrac Classic
- rollyFarmtrac Premium
- rollyX-Trac
- rollyTrac (Unimog)

**40 985 3 rollyTrac Air Tyres**

26x9,5 (2x)  
 32,5x11 (2x) 7,7 kg 1x  
 43x35,5x35,5 8,3kg 0,054 m<sup>3</sup>

4 006485 409853



**40 986 0 rollyTrac Air Tyres**

26x9,5 (2x)  
 32,5x11 (2x) 7,7 kg 1x  
 43x35,5x35,5 8,3kg 0,054 m<sup>3</sup>

4 006485 409860



**40 924 2 rollyTrac Air Tyres**

31x9,5 (2x)  
 32,5x11 (2x) 7,9 kg 1x  
 43x35,5x35,5 8,5 kg 0,054 m<sup>3</sup>

4 006485 409242



**Luftbereifung, 4 Stck.**  
 pneumatic wheels, 4 pieces  
 pneu souples, 4 pièces  
 ruote gonfiabili, 4 pezzi

- rollyMinitrac
- rollyKiddy
- rollyKid
- rollyJunior
- rollyFarmtrac
- rollyFarmtrac Classic
- rollyFarmtrac Premium
- rollyX-Trac
- rollyTrac (Unimog)

**40 958 7 rollyTrac Air Tyres**

31x9,5 (2x)  
 32,5x11 (2x) 7,9 kg 1x  
 43x35,5x35,5 8,5 kg 0,054 m<sup>3</sup>

4 006485 409587



**40 930 3 rollyTrac Air Tyres**

31x9,5 (2x)  
 32,5x11 (2x) 7,9 kg 1x  
 43x35,5x35,5 8,5 kg 0,054 m<sup>3</sup>

4 006485 409303





SET A:  308x98  310x95

rolyFarmtrac Classic

40 965 5 rolySnowgrip

30,8x9,8x2 1,7 kg 1x

22,5x14,5x10 1,8 kg 0,003 m<sup>3</sup>



SET B:  325x110  330x120  335x120

rolyJunior  
 rolyFarmtrac  
 rolyFarmtrac Premium

40 969 3 rolySnowgrip

33,5x12x2 1,9 kg 1x

22,5x14,5x10 2,0 kg 0,003 m<sup>3</sup>

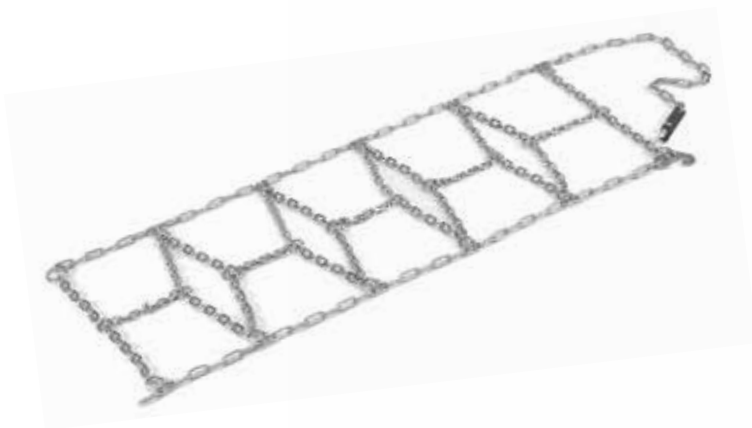

SET C:  390x150  395x150

40 966 2 rolySnowgrip

39x15x2 2,3 kg 1x

22,5x14,5x10 2,4 kg 0,003 m<sup>3</sup>



rolyX-Trac  
 rolyX-Trac Premium





## rollyFlashlight



tüüüt tüüüt



40 100 0 FerbedoMini Flash, blau



4 006485 401000

tüüüt tüüüt



40 101 7 FerbedoMini Flash, orange



4 006485 401017

40 955 6 rollyFlashlight

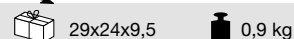
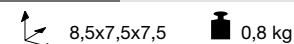

4 006485 409556



40 976 1 rollyFlashlight

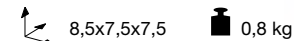

4 006485 409761



## rollyBrake



40 944 0 rollyTrac Brake (rollyFarmtrac)



4 006485 409440

- rollyJunior
- rollyFarmtrac
- rollyFarmtrac Classic
- rollyFarmtrac Premium

40 992 1 rollyTrac Brake (rollyX-Trac)

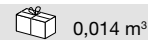

4 004099 216485

- rollyX-Trac
- rollyX-Trac Premium





rollyLight&Sound



40 959 4 rollyLight & Sound

20,4x8,4x6,4 0,8 kg 4x  
30,5x24x12,5 1,0 kg 0,009 m<sup>3</sup>



eine Lampe = drei Kombinationen  
one light = three combinations  
une lampe = trois possibilités de combinaison



rollySoundwheel

tüüüt tüüüt  
brm brm brm

40 923 5 rollySoundwheel

20x20x9 0,4 kg 1x  
20,5x20,5x9,5 0,5 kg 0,004 m<sup>3</sup>



ohne Batterien - without batteries  
sans batterie - batterie a parte



40 920 4 rollySoundwheel

20x20x9 3,2 kg VE 8x  
44x31x30 3,6 kg 0,041 m<sup>3</sup>



ohne Batterien - without batteries  
sans batterie - batterie a parte



rollyPylons

40 949 5 rollyPylons

23x13,5x13,5 3,4 kg 12x4  
44x31x30 3,8 kg 0,041 m<sup>3</sup>



4 Stk. im Set  
rolly pylons, set of 4  
Pylône rolly, Kit de 4 pièces  
Pilone rolly, 4 pz. compresi nel set





# VOLVO

The VOLVO trademarks (word and device), other related trademarks, if applicable, and the Volvo designs are licensed by the AB Volvo Group



1



2

**1 51 322 2 rollyDigger XL Volvo**

87x45x96 12,7 kg 1x

75x26x48 14,1 kg 0,094 m<sup>3</sup>



4 006485 513222

**2 51 321 5 rollyDigger XL CAT**

87x45x96 12,7 kg 1x

75x26x48 14,1 kg 0,094 m<sup>3</sup>



4 006485 513215

**3 42 115 2 rollyDigger Volvo**

102x43x74 4,1 kg 1x

47x41,5x32 5,0 kg 0,062 m<sup>3</sup>



4 006485 421152

**4 42 101 5 rollyDigger CAT**

102x43x74 4,1 kg 1x

47x41,5x32 5,0 kg 0,062 m<sup>3</sup>



4 006485 421015

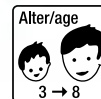



# rollyDigger

3



www.cat.com / www.caterpillar.com  
© 2022 Caterpillar. All Rights Reserved.  
CAT, CATERPILLAR, their respective logos,  
„Caterpillar Yellow,“ the „Power Edge“  
trade dress as well as corporate and product  
identity used herein, are trademarks of Caterpillar  
and may not be used without permission.  
rolly toys - Franz Schneider GmbH & Co. KG,  
a licensee of Caterpillar Inc.

2



4







# rollyDigger



1

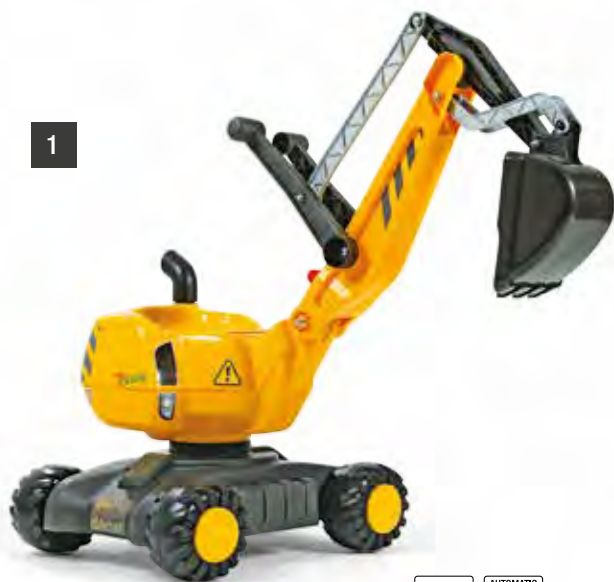

2



3



**JOHN DEERE**  
LICENSED PRODUCT



4



1 42 100 8 rollyDigger

102x43x74 4,1 kg 1x  
47x41,5x32 5,0 kg 0,062 m<sup>3</sup>



4 006485 421008

2 42 118 3 rollyDigger JCB

102x43x74 4,1 kg 1x  
47x41,5x32 5,0 kg 0,062 m<sup>3</sup>



4 006485 421022

3 42 102 2 rollyDigger John Deere

102x43x74 4,1 kg 1x  
47x41,5x32 5,0 kg 0,062 m<sup>3</sup>



4 006485 421022

4 42 116 9 rollyDigger Komatsu

102x43x74 4,1 kg 1x  
47x41,5x32 5,0 kg 0,062 m<sup>3</sup>



4 006485 421169

**KOMATSU**

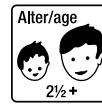

1



2



3

4



55 869 8  
rollySafety vest



8x



0,09 m<sup>3</sup>



5

1 26 155 0 Kegelspiel

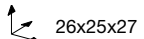

26x25x27

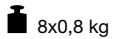

8x0,8 kg



8x

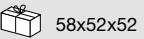

58x52x52



7,0 kg



0,157 m<sup>3</sup>



4 006485 261550

2 22 114 1 Stehaufclown



20,5x9,5x9,5

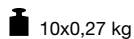

10x0,27 kg



10x

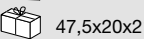

47,5x20x21,7

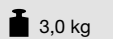

3,0 kg



0,021 m<sup>3</sup>



4 006485 221141

3 37 949 1 rollyShovel



4 006485 379491

4 37 950 7 rollyShovel



71x26x9

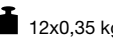

12x0,35 kg



12x

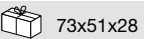

73x51x28

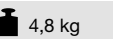

4,8 kg



0,104 m<sup>3</sup>



4 006485 379507

5 27 169 6 rollySchubkarre



70x30x33

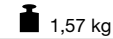

1,57 kg



6x

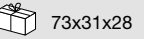

73x31x28

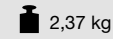

2,37 kg



0,063 m<sup>3</sup>



4 006485 271696



**1 27 184 9 rollyMetallschubkarre**

 80x30x41   
  2,2 kg   
  1x  
 49,5x38x13   
  2,7 kg   
  0,024 m<sup>3</sup>



**2 27 175 7 rollyMetallschubkarre**

 80x30x41   
  2,1 kg   
  1x  
 49,5x38x13   
  2,6 kg   
  0,024 m<sup>3</sup>



**3 27 181 8 rollyMetallschubkarre CAT**

 80x38x41   
  2,0 kg   
  1x  
 49,5x38x13   
  2,5 kg   
  0,024 m<sup>3</sup>





**4 27 080 4 rollyMetallschubkarre**

 80x38x41   
  2,0 kg   
  1x  
 49,5x38x13   
  2,5 kg   
  0,024 m<sup>3</sup>









**5 27 176 4 rollyMetallschubkarre**

 80x38x41   
  2,0 kg   
  1x  
 49,5x38x13   
  2,5 kg   
  0,024 m<sup>3</sup>









**6 27 480 2 rollyMetallschubkarre**

 80x38x41   
  2,0 kg   
  1x  
 49,5x38x13   
  2,5 kg   
  0,024 m<sup>3</sup>



**7 27 190 0 rollyMetallschubkarre**

 80x38x41   
  2,0 kg   
  1x  
 49,5x38x13   
  2,5 kg   
  0,024 m<sup>3</sup>





**8 27 087 3 rollySchubkarre**

 77x37x47   
  1,7 kg   
  1x  
 49,5x38x13   
  2,0 kg   
  0,024 m<sup>3</sup>



**9 27 085 9 rollySchubkarre**

 77x37x47   
  1,7 kg   
  1x  
 49,5x38x13   
  2,0 kg   
  0,024 m<sup>3</sup>



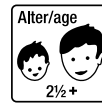

rollySommer

new

5



6



7



8



9





SNOW  
SHARK



1

Carving Bob



**1 20 070 2 rollySnow Shark**

	103x50x18,5		3,5 kg		1x
	104,5x50x20		4,2 kg		0,105 m <sup>3</sup>



**2 20 011 5 rollySnow Max**

	103x49x19		4,2 kg		1x
	104,5x50x20		4,9 kg		0,105 m <sup>3</sup>



**3 20 028 3 rollySnow Max**

	103x49x19		4,2 kg		1x
	104,5x50x20		4,9 kg		0,105 m <sup>3</sup>



**4 20 027 6 rollyJetstar, Display**

	93x41x22		4x2,0 kg		4x
	94x42x39		9,4 kg		0,154 m <sup>3</sup>



**5 37 949 1 rollyShovel**



**6 37 950 7 rollyShovel**

	71x26x9		12x0,35kg		12x
	73x51x28		4,8 kg		0,104 m <sup>3</sup>



**7 20 071 9 rollyCruiserseat**

	43x35x40		2,0 kg		1x
	51x26x40		2,6 kg		0,053 m <sup>3</sup>



2



3



4



5



6



7





# rollySnow Champions

## JOHN DEERE

LICENSED PRODUCT



8



9



www.cat.com / www.caterpillar.com  
© 2022 Caterpillar. All Rights Reserved.  
CAT, CATERPILLAR, their respective logos, „Caterpillar Yellow,“ the „Power Edge“ trade dress as well as corporate and product identity used herein, are trademarks of Caterpillar and may not be used without permission.  
rolly toys - Franz Schneider GmbH & Co. KG, a licensee of Caterpillar Inc.



10



11

### 8 20 016 0 rolySnow Cruiser John Deere

94x44x27 4,0 kg 1x  
 96x45x29 4,8 kg 0,125 m<sup>3</sup>



4 006485 200160

### 9 20 044 3 rolySnow Cruiser CAT

94x44x27 4,0 kg 1x  
 96x45x29 4,8 kg 0,125 m<sup>3</sup>



4 006485 200443

### 10 20 012 2 rolySnow Cruiser

94x44x27 4,0 kg 1x  
 96x45x29 4,8 kg 0,125 m<sup>3</sup>



4 006485 200122

### 11 20 029 0 rolySnow Cruiser

94x44x27 4,0 kg 1x  
 96x45x29 4,8 kg 0,125 m<sup>3</sup>



4 006485 200290





# Schach, Dame • Scacchi, tria dama Échecs et de dame • Chess and draughts

21 870 7

Große Schachfiguren • big chessmen  
grandes pièces d'échec • scacchi figure grande

64x24x24 2x13,6 kg 1x  
101x59x49 2x16,0 kg 0,292 m<sup>3</sup>



4 006485 218707

21 891 2

Kleine Schachfiguren • small chessmen  
petites pièces d'échec • scacchi figure piccole

29,5x13x13 4,7 kg 1x  
64,5x39x36 5,8 kg 0,091 m<sup>3</sup>



4 006485 218912



21 871 4

Große Dame Figuren • big draughts game pieces  
pions grand modèle • dama figure grande

25x25x9 13,1 kg 12x  
76x51x36,5 14,5 kg 0,150m<sup>3</sup>



4 006485 218714

21 889 9

Kleine Dame Figuren • small draughts game pieces  
pions petit modèle • dama figure piccole

10,5x10,5x4,5 2,0 kg 12x  
38x30,5x17,5 2,2 kg 0,020 m<sup>3</sup>



4 006485 218899



21 875 2

Großes Schachfeld • large chessboard  
grand échiquier • quadretto grande

36x36x1,5 18,8 kg 1x  
61x41x41 19,8 kg 0,103 m<sup>3</sup>



4 006485 218752

21 895 0

Kleines Schachfeld • small chessboard  
petit échiquier • quadretto piccolo

15,5x15,5x0,5 3,0 kg 1x  
47,5x20x21,7 3,3 kg 0,021 m<sup>3</sup>



4 006485 218950





rollyOutdoor Games



	218707	218912
	Höhe/Height (cm)	Höhe/Height (cm)
König – King	64	30
Dame – Queen	58	29
Läufer – Bishop	56	26
Pferd – Knight	48	21
Turm – Rook	43	21
Bauer - Pawn	43	20



# rolly toys Quality



## rolly toys Qualität zahlt sich aus!

rolly toys Funktionsspielwaren werden nach modernsten Erkenntnissen in Deutschland hergestellt und schon bei der Produktion durch die werksinterne Qualitätssicherung ständig auf Qualität und Funktionssicherheit überprüft. Zusätzlich werden die Funktionsspielzeuge nach den international verbindlichen Qualitätsstandards der europäischen Sicherheitsnorm EN 71 und teils ASTM (=US-Norm, gilt für Exportartikel nach USA) von unabhängigen Prüfinstituten getestet. Alle Funktionsspielzeuge von roly toys sind deshalb TÜV/GS zertifiziert und mit dem CE-Zeichen versehen.

Bei unseren Spielzeugen kommen nur physiologisch unbedenkliche Materialien zum Einsatz. Alle Farben, wie

auch Metallbeschichtungen, sind frei von Schwermetallen und entsprechen damit international akzeptierten Standards. In der Fertigung werden grundsätzlich umweltverträgliche Kunststoffe nach aktuellem Entwicklungsstand eingesetzt.

Durch die effektive Produktentwicklung bieten wir Ihnen ein breites, qualitativ hochwertiges und innovatives Sortiment zu einem sehr günstigen Preis-Leistungsverhältnis. Überzeugen sie sich von unserem anerkannten Lieferservice mit kurzen Lieferzeiten und sie schaffen für sich die Voraussetzung für gute Umsätze mit den in vielen Ländern bekannten und beliebten roly toys Artikeln.



## La qualità roly toys vale sempre la pena!

I giocattoli funzionali roly toys vengono prodotti in Germania, in conformità alle più moderne conoscenze e controllati continuamente, già durante la produzione, dal reparto qualità dell'azienda, per quanto riguarda la qualità e la sicurezza nel funzionamento. I giocattoli funzionali vengono inoltre testati in conformità agli standard di qualità internazionali vincolanti della norma europea EN 71 ed in parte ASTM (=norma US, vale per articoli d'esportazione verso gli USA) da istituti di controllo indipendenti. Tutti i giocattoli di funzionamento della roly toys sono quindi certificati TÜV/GS e dotati di simbolo CE.

Per la produzione dei nostri giocattoli, vengono utilizzati solo materiali che non presentano rischi dal punto di vista fisiologico. Tutti i colori, come anche le coperture metalliche, sono privi di metalli pesanti e corrispondono a standard riconosciuti su scala internazionale. Per la produzione si utilizzano fondamentalmente materiali plastici che rispettano l'ambiente e che sono conformi allo stato attuale dello sviluppo.

Con l'effettivo sviluppo del prodotto Le offriamo un ampio ed innovativo assortimento, di elevato pregio qualitativo con un ottimo rapporto qualità prezzo. Si assicuri del nostro apprezzato servizio di consegna, dai brevi tempi di consegna e si assicurerà il presupposto per buoni fatturati con gli articoli roly toys conosciuti ed amati in molti paesi.



made in Germany



www.tuv.com  
ID 0000960149



	
<b>Produktid. - No.:</b> 281 6090 / 014_1-4 <small>Teil-Nr. / Part No.</small>	<b>Seite 4 von 28</b> <small>Page 1 of 28</small>
<b>Auftraggeber:</b> Toys, Spielzeug, Spielzeug & Co. KG <small>Customer</small>	<b>Auftrag / Obj. Nr.:</b> <small>Order No.</small>
<b>Organisator und Prüfer:</b> TÜV SÜD AG <small>Organizer and Inspector</small>	
<b>Standort:</b> <b>Prüfobjekt:</b> <b>Material-Nr.:</b> <small>Location: Test object: Material No.:</small>	
<b>Prüfung:</b> TÜV (Technik) (24, Paddock-Greif), <b>Normen:</b> <small>Test: TÜV (Technik) (24, Paddock-Greif), Norms:</small>	
<b>Prüfungstermin:</b> 22.11.2011 <small>Test date:</small>	
<b>Prüfungsort:</b> 22, Paddock-Greif, 20110401, 2011 <small>Test location:</small>	
<b>Prüfungsergebnis:</b> Die Prüfungsergebnisse sind gemäss Prüfprotokoll. <small>Test result: The test results are according to the test protocol.</small>	
<b>Prüfungstermin:</b> 22.11.2011 <small>Test date:</small>	
<b>Prüfungsort:</b> 22, Paddock-Greif, 20110401, 2011 <small>Test location:</small>	
<b>Prüfungsergebnis:</b> Die Prüfungsergebnisse sind gemäss Prüfprotokoll. <small>Test result: The test results are according to the test protocol.</small>	

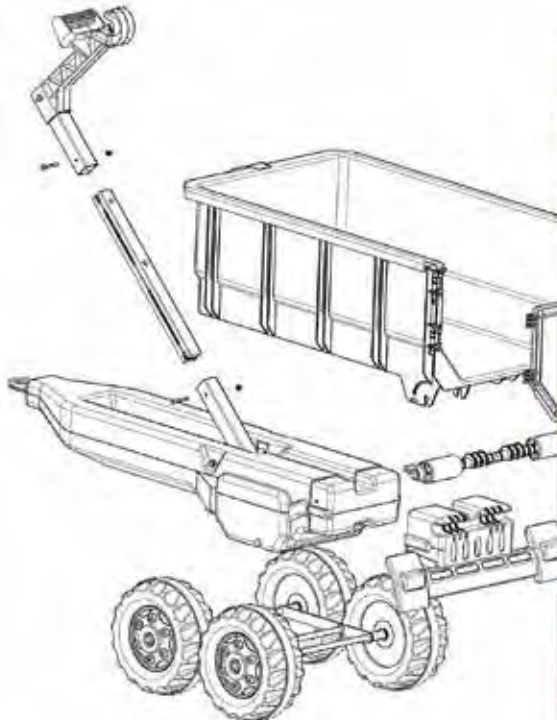

**rolly toys quality pays off!**

rolly toys function toys are manufactured in Germany according to the latest findings and are constantly examined, right from production, for quality and functional reliability by way of internal quality assurance. In addition, the function toys are tested by independent testing institutes in accordance with the internationally mandatory quality norms of the European safety standard EN 71 and in some cases, ASTM (=US standard, applies to export articles to the USA). Thus all function toys of roly toys are certified by the German Technical Inspection Authority (TÜV), safety tested (GS) and carry the CE mark.

Only physiologically harmless materials are used in the making of our toys. All colours as well as metal coatings are free from heavy metals and therefore meet internationally accepted standards. Only environmentally compatible plastics are used in the manufacturing process according to the current level of research.

Due to effective product development, we are able to offer you a wide, high-quality and innovative range at a very favourable price/performance ratio. Try out our accredited delivery service with short delivery times, and you will have the right base for good sales with the roly toys articles that are famous and popular in many countries.



**La qualité roly toys en vaut la peine!**

Les jouets fonctionnels roly toys sont fabriqués en Allemagne selon les acquis les plus modernes et constamment réexaminées dès la production par l'assurance qualité interne du producteur en ce qui concerne la qualité et la sécurité de fonctionnement. De plus, les jouets fonctionnels sont testés au niveau international par des instituts de contrôle indépendants selon les normes de qualité obligatoires de la norme de sécurité EN Européenne 71, et en partie également de la norme US ASTM pour les articles d'exportation vers les USA. Tous les jouets fonctionnels roly toys sont par conséquent certifiés par le service des Mines allemand et livrés avec le sigle CE.

Seuls des matériaux physiologiquement inoffensifs sont utilisés pour nos jouets. Toutes les teintes et les revêtements métallisés sont libres de métaux lourds et correspondent ainsi au niveau international aux normes admises. Seules les matières plastiques systématiquement écologiques sont utilisées dans la fabrication selon le niveau actuel de la recherche.

De par notre développement effectif de produit, nous vous offrons un large assortiment de grande qualité et innovateur pour un rapport performance/prix très favorable. Faites la preuve de notre service livraison éprouvé avec courts délais de livraison et vous créez la condition d'excellents chiffres d'affaires grâce aux articles roly toys populaires dans de nombreux pays.





Art.Nr	Bezeichnung	Seite	Art.Nr	Bezeichnung	Seite	Art.Nr	Bezeichnung	Seite
<b>rollyKid</b>			12 210 3	rollyFarm Trailer John Deere	72	<b>rollySnow Champions</b>		
01 184 1	rollyKid Landini Power Farm 100, rollyKid Trailer	24	12 212 7	rollyTanker silber, Zweiachser	68	20 011 5	rollySnowMax rot	92
01 212 1	rollyKid-X, rollyKid Trailer	16	12 215 8	rollyTimber Trailer, Zweiachskipper, grün	71	20 012 2	rollySnowCruiser rot	93
01 215 2	rollyKid Zetor Forterra 135	20	12 216 5	rollyHalfpipe John Deere	64	20 016 0	rollySnowCruiser John Deere	93
01 216 9	rollyKid-X, rollyKid Trailer	17	12 220 2	rollyMega Trailer grün	62	20 027 6	rollyJetstar, Display	92
01 219 0	rollyKid John Deere, rollyKid Trailer	25	12 221 9	rollyHalfpipe CLAAS	65	20 028 3	rollySnowMax blau	92
01 230 5	rollyKid MF, rollyKid Trailer	20	12 224 0	rollyHalfpipe Deutz-Fahr	64	20 029 0	rollySnowCruiser blau	93
01 241 1	rollyKid Case CVX1170, rollyKid Trailer	20	12 226 4	rollyHalfpipe Joskin	67	20 044 3	rollySnow Cruiser CAT	93
01 251 0	rollyKid Steyr 6165 CVT, rollyKid Trailer	22	12 247 9	rollyHaywagon Pöttinger	71	20 070 2	rollySnowShark	92
01 252 7	rollyKid Valtra, rollyKid Trailer	24	12 265 3	rollyTanker Fendt grün, Zweiachser	68	20 071 9	rollyCruiserseat	92
01 261 9	rollyKid JCB, rollyKid Trailer	26	12 275 2	rollyTanker John Deere, Zweiachser, rollyPompa	69	<b>rollyOutdoor Games</b>		
01 307 4	rollyKid NewHolland T 7040, rollyKid Trailer	23	12 277 6	rollyTanker silber, rollyPompa	68	21 870 7	rollySchachfiguren	94
01 316 6	rollyKid Fendt Vario 516, rollyKid Trailer	21	12 286 8	rollyVacumax grün, rollyPompa	69	21 871 4	rollyDamesteine	94
01 494 1	rollyKid Little Grey Fergie	19	12 296 7	rollyFire rot, rollyPompa	69	21 875 2	rollySchachfeld	94
<hr/>			12 298 1	rollyHay Wagon grün, Einachskipper	71	21 889 9	rollyDamesteine	94
02 311 0	rollyKid John Deere, rollyKid Lader, rollyKid Trailer	25	12 301 8	rollyMega Trailer rot	63	21 891 2	rollySchachfiguren	94
02 312 7	rollyKid-X, rollyKid Lader, rollyKid Trailer rot	16	12 319 3	rollyHalfpipe Single	64	21 895 0	rollySchachfeld	94
02 313 4	rollyKid-X, rollyKid Lader, rollyKid Trailer grün	17	12 320 9	rollyMulti Trailer Joskin	67	<b>rollyClassic Summer</b>		
02 319 6	rollyKid Deutz 5115 G TB, rollyKid Lader, rollyKid Trailer	19	12 322 3	rollyContainer Krampe	67	22 114 1	Stehaufclown, Glockensound	89
02 328 8	rollyKid CAT, rollyKid Lader, rollyKid Trailer	27	12 323 0	rollyHalfpipe Krampe	65	26 155 0	Kegelspiel	89
02 383 7	rollyKid JCB, rollyKid Lader, rollyKid Trailer	26	12 326 1	rollyHalfpipe Krampe, HP 20, schwarz	65	27 080 4	Metallschubkarre rot	90
02 392 9	rollyKid New Holland T 7040, rollyKid Lader, rollyKid Trailer	23	12 381 0	rollyFarm Roller	74	27 085 9	Schubkarre gelb/rot, Metall/Kunststoff	91
02 393 6	rollyKid Steyr 6165 CVT, rollyKid Lader, rollyKid Trailer	22	12 384 1	rollyCambridge	74	27 087 3	Schubkarre grün/gelb, Metall/Kunststoff	91
02 417 9	rollyDumperKid CAT	27	12 386 5	rollyScraper	74	27 175 7	Metallschubkarre, Luftbereifung	90
02 424 7	rollyDumperKid JCB	26	12 393 3	rollyContainer, Trailer mit zwei Containern	66	27 176 4	rollySchubkarre silber/blau	NEU 91
02 507 7	rollyKid Claas Elios	21	12 500 5	rollyMulti Trailer grün, Zweiachskipper	61	27 181 8	Metallschubkarre CAT	90
<hr/>			12 501 2	rollyMulti Trailer grün, Dreiachskipper	60	27 184 9	Metallschubkarre, Doppelbereifung	90
<b>rollyTrucks</b>			12 504 3	rollyMulti Trailer John Deere, Dreiachskipper	60	27 190 0	Metallschubkarre grün	91
03 822 0	rollyUnimog Fire, rollyBrake, Schaltung	54	12 509 8	rollyContainer John Deere	66	27 480 2	Metallschubkarre pink	91
03 825 1	rollyUnimog Polizei	55	12 510 4	rollyStreumax Amazone	73	37 949 1	rollySchneeschaufel grün	92
03 823 7	rollyUnimog Service	54	12 511 1	rollyStreumax Trailer John Deere	73	37 950 7	rollySchneeschaufel rot	92
03 824 4	rollyUnimog Forst, rollyPowerwinch	55	12 881 5	rollyKipper II rot	72	<b>rollyAccessories</b>		
04 669 0	rollyFarmtrac MB, rollyTrac Lader, Schaltung, rollyBrake	38	12 882 2	rollyKipper II John Deere	72	40 100 0	Ferbedo Mini Flash blau	84
<hr/>			12 884 6	rollyKipper II blau	72	40 101 7	Ferbedo Mini Flash orange	84
<b>rollyDreiradtrac</b>			12 885 3	rollyKipper II Claas	72	40 892 4	rollyBox Claas	75
05 276 9	rollyTrac John Deere, Soundwheel, rollyKid Trailer	25	<b>rollyMinitrac</b>			40 893 1	rollyBox grün/gelb	75
05 293 6	rollyTrac CAT, Soundwheel, rollyKid Trailer	NEU 27	13 201 0	rollyMinitrac Steyr 4115 Multi	10	40 894 8	rollyBox silber/rot	75
<hr/>			13 207 2	rollyMinitrac John Deere 6150R	11	40895 5	rollyTrac Lader Premium	77
<b>rollyTrailer</b>			13 208 9	rollyMinitrac NH T6010	10	40 896 2	rollyTrac Lader Premium black	78
12 110 6	rollyMega Trailer blau	62	13 210 2	rollyMinitrac Deutz-Fahr Agrokid 230	13	40 898 6	rollyPowerwinch grün	78
12 150 2	rollyMega Trailer grün	62	13 214 0	rollyMinitrac Dumper	12	40 899 3	rolly Snowmaster grün	79
12 171 7	rollyKid Trailer rot	72	13 224 9	rollyMinitrac CAT Dumper	12	40 900 6	rollyPowerwinch gelb	78
12 172 4	rollyKid Trailer grün	72	13 226 3	rollyMinitrac Case CVX 165	10	40 918 1	rollyAir Tyres für Trakt. 4 x 310x95 silber	82
12 174 8	rollyKid Trailer grün	72	13 233 1	rollyMinitrac MF 5470	10	40 920 4	rollySoundlenkrad = 8x 409235	85
12 176 2	rollyKid Trailer blau	72	13 239 3	rollyMinitrac Valtra	13	40 923 5	rollySoundlenkrad	85
12 200 4	rollyMega Trailer grün	63	13 242 3	rollyMinitrac Carabella	14	40 924 2	rollyLuftbereifung für Trakt. 2 x 310x95, 2 x 325x110 silber	82
12 202 8	rollyMinitrac Trailer John Deere	11	13 256 0	rollyMinitrac Volvo mit Anhänger	14	40 928 0	rollyPowerwinch schwarz	78
12 208 0	rollyMinitrac Trailer rot	13	13 265 2	rollyMinitrac Claas Xerion	13	40 930 3	rollyLuftbereifung für Trakt. 2 x 310x95, 2 x 325x110 gelb	82
12 209 7	rollyFarm Trailer rot/silber	72	13 277 5	rollyMinitrac Lindner	13	40 931 0	rollyKid Lader silber	76
<hr/>			13 564 6	rollyMinitrac JCB Dumper	12	40 932 7	rollyHeckbagger rot	80
<b>rollyMiniTruck</b>			<hr/>			40 933 4	rollyJunior Lader silber	76
16 100 3	rollyMiniTruck Mack	15	<b>rollySnow Champions</b>			40 934 1	rollyTrac Lader schwarz	76
16 101 0	rollyMiniTruck Mack	15	<hr/>			40 935 8	rollyHeckbagger John Deere	81

# Artikelliste

Art.Nr	Bezeichnung	Seite	Art.Nr	Bezeichnung	Seite	Art.Nr	Bezeichnung	Seite
40 939 6	rollyTrac Lader	76	61 109 6	rollyFarmtrac John Deere 6210R, rollyTrac Lader	39	71 029 4	rollyFarmtrac Premium II Fendt 939, rollyTrac Lader, rolyTrac Air Tyres, rollyTrac Brake, Schaltung,	<b>NEU 50</b>
40 940 2	rollyPompa	69	61 110 2	rollyFarmtrac John Deere 6210R, rollyTrac Lader, rolyTrac Air Tyres	39	71 034 8	rollyFarmtrac Premium Deutz Warrior Agrottron 7250 TTV, rolyTrac Lader	44
40 944 0	rollyBrake (rollyFarmtracs)	84	61 112 6	rollyFarmtrac Case Puma CVX 240, rollyTrac Lader, rolyTrac Air Tyres.	36	71 040 9	rollyFarmtrac Premium Valtra, rollyTrac Lader	51
40 949 5	rollyPylone (Set = 4 Stück)	85	61 113 3	rollyFarmtrac MF 8650, rolyTrac Lader	32	72 000 2	rollyFarmtrac Premium Steyr 6300 Terrus CVT	<b>NEU 42</b>
40 955 6	rollyFlashlight orange = 4 x 40 978 5	84	61 114 0	rollyFarmtrac MF 8650, rolyTrac Lader, rollyTrac Air Tyres	32	72 003 3	rollyFarmtrac Premium II Valtra ab 08/2022	<b>NEU 51</b>
40 958 7	rollyLuftbereifung für Trakt. 2 x 310x95, 2 x 325x110 rot	82	61 120 1	rollyFarmtrac Deutz-Fahr 5120, rollyTrac Lader	34	72 005 7	rollyFarmtrac Premium II Deutz 8280 TTV ab 2. HJ 2022	<b>NEU 46</b>
40 959 4	rollyLight & Sound	85	61 121 8	rollyFarmtrac Deutz-Fahr 5120, rollyTrac Lader, rolyTrac Air Tyres	34	72 006 4	rollyFarmtrac Premium II CLAAS Arion 640	<b>NEU 41</b>
40 961 7	rollySnow Master	79	61 125 6	rollyFarmtrac New Holland T7, rollyTrac Lader	37	72 007 1	rollyFarmtrac Premium II Lintrac	<b>NEU 52</b>
40 963 1	rollyRundholz (Set = 6 Stück)	71	61 127 0	rollyFarmtrac New Holland T7, rollyTrac Lader, rolyTrac Air Tyres	37	73 000 1	rollyFarmtrac Premium II Steyr 6300 Terrus CVT, rolyTrac Lader	<b>NEU 42</b>
40 965 5	rollySnowgrip 2 Stck. für Rad 308x98	83	<b>rollyKiddy</b>			73 002 5	rollyFarmtrac Premium II Steyr 6300 Terrus CVT, rollyTrac Lader, rolyTrac Air Tyres	<b>NEU 42</b>
40 966 2	rollySnowgrip 2 Stck. für Rad 390x150	83	62 000 5	rollyKiddy Futura, rolyKid Trailer	18	73 003 2	rollyFarmtrac Premium II John Deere 7310R, rollyTrac Lader	<b>NEU 48</b>
40 967 9	rollyTimber Loader, Anbausatz	77	63 003 5	rollyKiddy Futura, rolyKid Trailer, rollyKid Lader	18	73 005 6	rollyFarmtrac Premium II Valtra, rollyTrac Lader ab 08/2022	<b>NEU 51</b>
40 969 3	rollySnowgrip 2 Stck. für Rad 335x120	83	63 004 2	rollyKiddy Classic, rolyKid Trailer, rollyKid Lader	19	73 008 7	rollyFarmtrac Premium II Deutz 8280 TTV, rollyTrac Lader ab 2. HJ 2022	<b>NEU 46</b>
40 970 9	rollyTrac Sweeper	78	<b>rollyX-Trac Premium</b>			73 009 4	rollyFarmtrac Premium II Deutz, rolyTrac Lader, rollyTrac Air Tyres ab 2. HJ 2022	<b>NEU 46</b>
40 971 6	rollyTrac Sweeper John Deere	81	64 003 4	rollyX-Trac Premium, John Deere 8400 R	<b>NEU 56</b>	73 010 0	rollyFarmtrac Premium II CLAAS Arion 640, rollyTrac Lader	<b>NEU 41</b>
40 972 3	rollySweepy orange	78	64 008 9	rollyX-Trac Premium CLAAS Axion 940	58	73011 7	rollyFarmtrac Premium II Lintrac, rollyTrac Lader	<b>NEU 52</b>
40 976 1	rollyFlashlight blau = 4x 40 975 4	84	65 100 9	rollyX-Trac Premium, rolyTrac Lader Premium	59	<b>rollyJunior</b>		
40 984 6	rollyTrac Air Tyres für Trakt. 2 x 260x95, 2 x 325x110, silber	82	65 101 6	rollyX-Trac Premium, rolyTrac Lader Premium, Schaltung, rolyTrac Brake	59	80 026 1	rollyJunior RT rot, rolyFarm Trailer	28
40 985 3	rollyTrac Air Tyres für Trakt. 2 x 260x95, 2 x 325x110, rot	82	65 104 7	rollyX-Trac Premium John Deere 8400 R, rollyTrac Lader Premium	56	81 107 6	rollyJunior John Deere, rolyJunior Lader, rollyHeckbagger	30
40 986 0	rollyTrac Air Tyres für Trakt. 2 x 260x95, 2 x 325x110, gelb	82	65 105 7	rollyX-Trac Premium, John Deere 8400 R rollyTrac Lader P., Schaltung, rollyTrac Brake	<b>NEU 57</b>	81 139 7	rollyJunior RT rot, rolyJunior Lader, rollyFarm Trailer	29
40 988 4	rollySweepy grün	78	65 109 2	rollyX-Trac Premium CLAAS Axion 950, rollyTrac Lader Premium	58	81 146 5	rollyJunior RT grün, rolyJunior Lader	28
40 992 1	rollyBrake (rollyX-Trac)	<b>NEU 84</b>	65 112 2	rollyX-Trac Premium CLAAS Axion 960, rollyTrac Lader P., Schaltung, rolyTrac Brake	58	81 200 4	rollyJunior JCB, rolyJunior Lader, rollyHeckbagger	31
<b>rollyDigger Kunststoff</b>			<b>rollyFarmtrac Premium</b>			81 300 1	rollyJunior CAT, rolyJunior Lader, rollyHeckbagger	30
42 100 8	rollyDigger	88	70 002 8	rollyFarmtrac John Deere 7930	49	<b>rollyTruck</b>		
42 101 5	rollyDigger CAT	87	70 003 5	rollyFarmtrac Deutz-Fahr Agrottron 7250 TTV	44	88 100 0	rollyTruck Volvo	53
42 102 2	rollyDigger John Deere	88	70 027 1	rollyFarmtrac Valtra	50	<i>Es gelten unsere allgemeinen Lieferbedingungen auf der Preisliste. Technische Änderungen und Farbänderungen bleiben vorbehalten.</i>		
42 115 2	rollyDigger Volvo	87	71 002 7	rollyFarmtrac Premium John Deere 7930, rollyTrac Lader	48	<i>Our general delivery conditions written on the price list are valid. All rights are reserved to make any technical modifications and colour changes.</i>		
42 116 9	rollyDigger Komatsu	88	71 003 4	rollyFarmtrac Premium Deutz Agrottron 7250 TTV, rolyTrac Lader	44	<i>Nous appliquons les conditions de livraison indiquées sur nos tarifs. Sous réserve de modifications techniques et de changements de teintes.</i>		
42 118 3	rollyDigger JCB	88	71 012 6	rollyFarmtrac Premium John Deere 7930, rollyTrac Lader, rolyTrac Air Tyres, rollyTrac Brake, Schaltung.	48	<i>Sono valide tutte le condizioni scritte riportate a listino. Ci riserviamo tutti i diritti di apportare modifiche tecniche e cambiamenti di colore</i>		
<b>rollyDigger Metall</b>			71 013 3	rollyFarmtrac Premium Deutz Agrottron 7250 TTV, rolyTrac Lader, rolyTrac Air Tyres	44			
51 321 5	rollyDigger XL CAT	86	71 026 3	rollyFarmtrac Premium Fendt Vario 940, rollyTrac Lader	50			
51 322 2	rollyDigger XL Volvo	86						
<b>Farmers' Shop</b>								
55 869 8	rollySafety vest	89						
<b>rollyFarmtrac</b>								
60 102 8	rollyFarmtrac Fendt 211 Vario	33						
60 104 2	rollyFarmtrac Claas Axos 340	40						
60 105 9	rollyFarmtrac Case Puma CVX 240	36						
60 106 6	rollyFarmtrac John Deere 6210R	38						
60 115 8	rollyFarmtrac MF 8650	32						
60 124 0	rollyFarmtrac Deutz-Fahr 5120	34						
60 129 5	rollyFarmtrac New Holland T7	37						
60 131 8	rollyFarmtrac FIAT Centenario	35						
61 100 3	rollyFarmtrac JCB 8250, rolyTrac Lader	35						
61 104 1	rollyFarmtrac Claas Axos 340, rolyTrac Lader	40						
61 105 8	rollyFarmtrac Fendt 211 Vario, rolyTrac Lader	33						
61 106 5	rollyFarmtrac Case Puma CVX 240, rollyTrac Lader	36						
61 108 9	rollyFarmtrac Fendt 211 Vario, rollyTrac Lader, rolyTrac Air Tyres	33						



# Vertretungen national

National representative • Représentations nationales • rappresentanti nazionali

Auftragsannahme Neustadt: FAX + 49 (0) 9568-856195, inland@rollytoys.de

## Bert Stoklossa Industriervertretungen

Bert Stoklossa  
Missionsweg 18, 21220 Seevetal  
Fon 04185 - 792022 • Fax 04185 - 792023  
E-Mail: bert@stoklossa-iv.de

## Handelsagentur Paus

Norbert Paus  
Kurfürstenstraße 38, 46399 Bocholt  
Fon 02871 - 48530  
Fax 02871 - 487330  
E-Mail: norbert@ha-paus.de

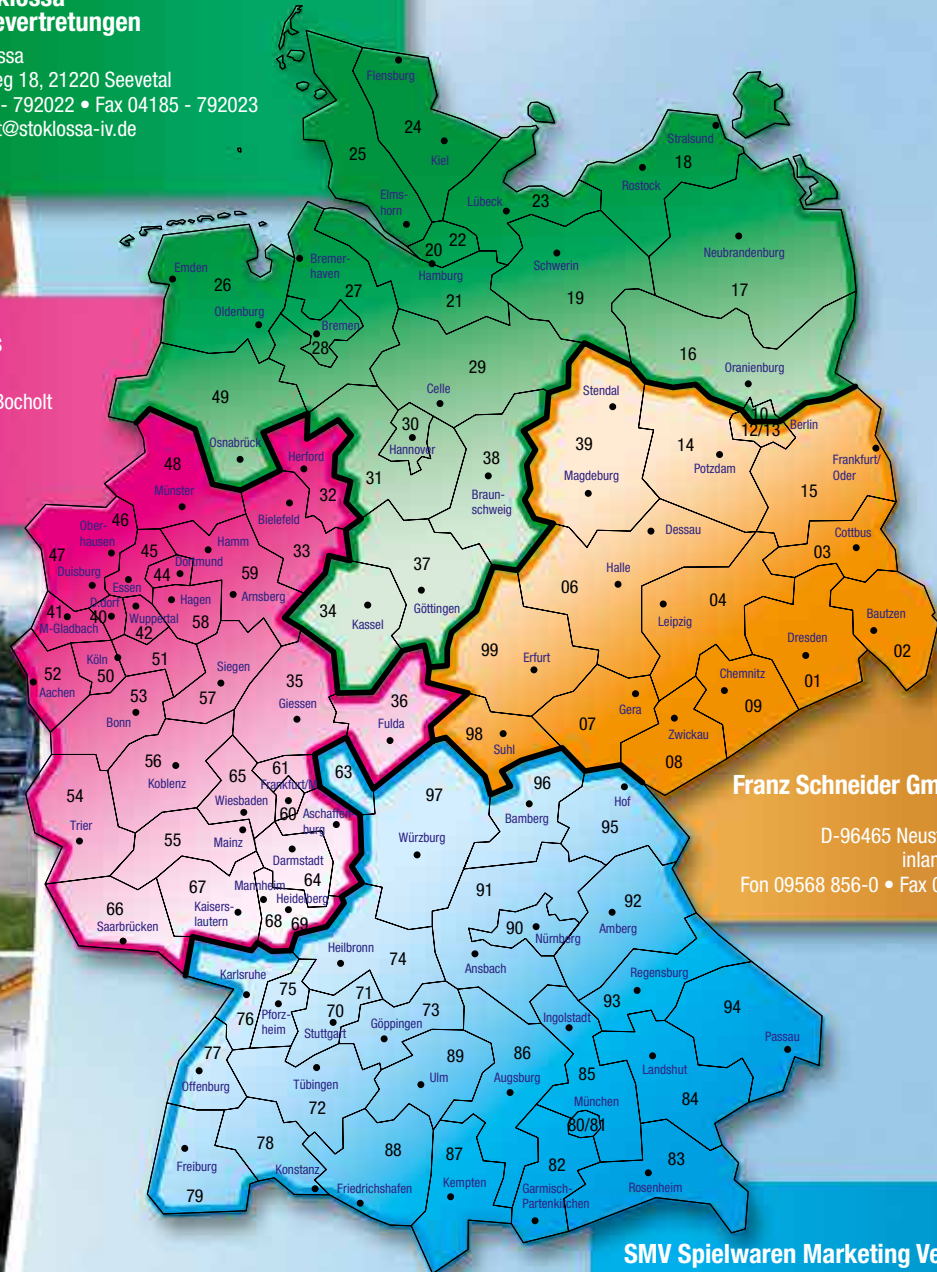

**Franz Schneider GmbH & Co. KG**  
Postfach 1460  
D-96465 Neustadt bei Coburg  
inland@rollytoys.de  
Fon 09568 856-0 • Fax 09568 856-195

## SMV Spielwaren Marketing Vertrieb Reinhard Simon & Bernd Markmiller OHG

Reinhard Simon, Bernd Markmiller  
Alexander Rieger, Renate Eibich  
Dieselstraße 16, 86368 Gersthofen  
Fon 0821 - 780851-0 • Fax 0821 - 780851-10  
E-Mail: office@smv-spielwaren.de



## Die Marke für Kinderfahrzeuge

The brand for children's vehicles  
La marque de véhicules pour enfants  
La marca di veicoli per bambini



# Vertretungen international

International representative • Représentations internationales • Rappresentanti internazionali

**Auftragsannahme / order acceptance Neustadt: FAX + 49 (0) 9568-856182**



## AT Handelsagentur Kundegraber

Rosengasse 2, 2431, Enzersdorf, Tel.: 02230 79079  
Fax: 02230 7907989, email: office@kundegraber.at

## AUS TOMY Australia Pty. Ltd.

942 - 956 Taylors Rd, VIC 3175, Dandenong South, Tel: 03 9799 5500  
email: serviceaus@tomyaust.com, web: www.tomy.com

## BE/LUX Born Agenturen

Regenboog 8, 3742 ZB Baarn, Tel.: 035 6468 299  
email: info@rollytoys.nl, web: www.rollytoys.nl

## CA Walco Equipment Limited

20 Arthur St. N., Elmira, Ontario N3B 1Z9, Tel.: 0519 669 4025  
email: orders@walcoequipment.com, web: www.walcoequipment.com

## CH Sombo AG

Aaraustraße 16, 5103 Wildegg, Tel.: 062 887 7474,  
Fax: 062 887 7457, email: info@sombo.ch, web: www.sombo.ch

## CN Beijing Qisehua Educational Science Developing Co. Ltd.

South Building of Village Party Committee's Office,  
Changxing Village, Xiaotangshan Town  
Changping District, 102211 Beijing, Tel.: 61 79 09 79,  
Fax: 61 79 09 63, email: qisehua@qisehua.cn, web: www.qisehua.cn

## CY Kostakis D. Koureas & Son Ltd.

26, Georgiou Karaiskaki, 4193 Ypsonas / Limassol, Tel: 025 711 702  
Fax: 025 711 332, email: kdkoureas@cytanet.com.cy  
web: www.koureas.com

## CZ OLYMPTOY s.r.o.

Okružní ulice 781, 25081 Nehvizdy, Tel.: 321 740 100  
email: info@olymptoy.cz, web: www.olymptoy.cz

## DK Great Goods

Stockholmsgade 35, 2100 Copenhagen, Tel.: 022 170 294  
email: bb@greatgoods.dk, web: www.GreatGoods.dk

## For the Agricultural market:

Kramp Danmark A/S  
Kobbervej 6, 6900 Skjern, Tel.: 09680 8500  
email: kramp.dk@kramp.com, web: nordic.kramp.com

## EE AS Salome Auto

Kadaka Tee 42 a, 12915 Tallinn, Tel.: 0680 8802  
email: info@automaailm.ee, web: www.automaailm.ee

## ES Dream Toys

Nucleo Empresarial Venda do Norte, Rua B, n 25 e 26  
2665-601 Venda do Pinheiro, Tel: 021 759 70 48, Fax: 021 115 60 81  
email: geral@dreamtoys.pt, web: www.dreamtoys.pt

## Grupo Noropasa S.L.

C/Paraiso 58 Bajo, 15680 Ordes A Coruña, Tel: 0981 68 10 62  
email: info@agrojuguetes.com, web: www.agrojuguetes.com

## FI Toyrock OY

Lemminkäisenkatu 46, 20520 Turku Tel.: 040 595 5233  
email: purchasing@toyrock.fi, web: www.toyrock.fi

## FR AB Développement

70 Chemin Pré Paris, 74540 Cusy, Tel.: 0450 882 107  
email: contact@ab-developpement.com

## GB Robbie Toys Ltd.

Unit 1 The Lane, Manston Business Park, CT12 5EZ, Manston, Kent  
Tel.: 01843 604 448, email: sales@robbietoys.co.uk,  
web: www.robbietoys.co.uk

## HU VEGA-IMPEX Kft.

Ady Endre út 104, 2132 Göd, Tel.: 0273 318 39  
email: info@vegatoys.hu, web: www.vegatoys.hu

## IDN Toys Kingdom – PT. Toys Games Indonesia

Kawan Lama Building 7th floor, JL Puri Kencana No. 1  
Kembangan Selatan, Jakarta Barat, 11610, Tel.: 21 582 9006  
email: smile@toyskingdom.co.id, web: www.toyskingdom.co.id

## IL Gabriel Perez

27 Hayarden Str., 76603 Rehovot, Tel.: 08 8692247, mobile: 05 447 02444  
Fax: 08 9416740, email: gabitoys@inter.net.il

## IN Toycra

2nd Floor, Indraprasth Corp. Opp. Venus Atlantis, Anandnagar Road  
Prahlanagar, Ahmedabad 380015, Tel.: 09879 110650,  
email: toycra@gmail.com, web: www.toycra.com

## IRL Banaghan & Co. Ltd.

Nenagh Co Tipperary, Tel.: 067 63800  
Fax: 067 63801, email: info@banaghans.ie, web: www.banaghans.ie

## IS Afivelar ehf

Vesturhraun 3, 210 Garoabaer, Tel.: 4800 400  
email: ba@afivelar.is, web: www.afivelar.is

## IT Rolly Toys Italiana S.R.L.

Via Colonna 9, 31025 S.Lucia di Piave  
Tel.: 0438 4466, Fax: 0438 27372, email: info@rollytoys.it

## JP Job International Ltd.

3-34-8, Tarumicho, Suitashi, Osaka 564-0062, Tel.: 066 368 9911  
Fax: 066 368 9701, email: info@job-toys.com, web: www.job-toys.com

## KR Nabita World Co., Ltd.

5th Fl., 35-28, Arayuk-ro 58beon-gil, Gochon-eup, Gimpo-si  
Gyeonggi-do, 10136, Tel.: 031 996 8855, Fax: 031 987 0522  
email: info@nabita.com, web: www.nabita.com

## LV SIA „Tommy Toys Story“

Duntes iela 11 lit. 2, 1013 Riga, Tel.: 027 000 483  
email: aigars.jegeris@tommytoys.lv, web: www.tommytoys.lv

## MY Kids Treasures Pte. Ltd. (Malaysia Branch)

B-G-03 (Retail 3) Gateway Kiaramas, No 1, Jalan Desa Kiara  
Mont Kiara, 50480 Kuala Lumpur, Tel.: 620 65484  
email: info@kidstresures.com.my, web: www.kidstresures.com.my

## NL Born Agenturen

Regenboog 8, 3742 ZB Baarn, Tel.: 035 6468 299  
email: info@rollytoys.nl, web: www.rollytoys.nl

## NO Great Goods

Stockholmsgade 35, 2100 Copenhagen, Tel.: 022 170 294  
email: bb@greatgoods.dk, web: www.GreatGoods.dk

## NZ TOMY Australia Pty. Ltd.

942 - 956 Taylors Rd, VIC 3175 Dandenong South, Tel: 03 9799 5500  
email: serviceaus@tomyaust.com, web: www.tomy.com

## PL Brimarex Sp. z o.o.

Ostroroga 8/4, 60-349 Poznan, Tel: 061 862 0701  
email: poznan@brimarex.pl, web: www.brimarex.pl

## PT Dream Toys

Nucleo Empresarial Venda do Norte, Rua B, n 25 e 26, 2665-601  
Venda do Pinheiro, Tel: 021 759 70 48, Fax: 021 115 60 81  
email: geral@dreamtoys.pt, web: www.dreamtoys.pt

## RS Cobratoys d.o.o.

Stojana Cupica 15, 15000 Sabac, Tel.: 015 710 0525  
Fax: 015 710 0520, email: kontakt@cobratoys.rs, web: www.cobratoys.rs

## RO RT Center Srl.

11 A, Bobalna Str., 550155 Sibiu, Tel.: 0742 141 585  
email: contact@rollytoys.ro, web: www.rollytoys.ro

## RU VIP Toys Company

Russian Federation, Alleja Pervoy Mayevki, dom 15, Stroenie 9-10 Moscow  
Tel.: 0495 799 3539, email: unrealsale@yandex.ru, web: www.viptoys.ru.com

## SE SpeedGame AB

Räkvägen 30, 237 36 Bjärred, Tel.: 0737 202475  
email: jenny@spgame.se, web: www.speedgame.se

## SG Kids Treasures Pte. Ltd.

1002 Jalan Bukit Merah #04-11, 159456 Singapore, Tel.: 6872 3912  
email: info@kidstresures.com.sg, web: www.kidstresures.com.sg

## SK Tinaco / Dracik - Duvi SK,

Logisticke Centrum Prologis, Dialnicna cesta 2, Hala2, 90301, Senec, SR  
Tel.: 0245 944 626, ext. 115, Fax: 0245 944 628  
email: office@dracik.sk, dracik@dracik.sk, web: www.dracik.sk

## SI Moko d.o.o.

Vir, Litjiska 1, 01230 Domzale, Tel.: 017 295 -120, or -124  
email: info@moko.si, web: www.moko.si

## UA LLC CarSeats

Georgy Toropovsky str. 2, of 51, 02100 Kiev, Tel.: 044 353 87 09  
Email: zakaz@carseats.com.ua, web: www.avtokrisla.com

## USA KETTLER® Int'l., Inc. USA

1355 London Bridge Road, Virginia Beach, VA 23453  
Tel.: 757 427 2400, Fax: 757 427 0183  
email: toys@kettlerusa.com, web: www.kettlerusa.com

## VAE Arwani Middle East FZCO

Plot No. S 51201 Jebel Ali Freezone, Dubai, Tel.: 4 2828 223  
email: info@arwani.ae, web: www.arwani.ae

## ZA Tool and Professional Services

27 Walnut Ave, Breananda 1739  
Tel.: 011 955 1243, Fax: 011 955 2100  
email: pieter@toolandprof.co.za, web: www.toolandprof.co.za



*...hat das Zeug  
zum Spielen*



**Franz Schneider GmbH & Co. KG**

■ made  
■ in  
■ Germany